



Headquarters

Ruilu Group China

No.2666, KaiFaqu Avenue, Rui'an Economic Development Zone, Zhejiang Province, 325200, China
 Tel: 0086-577-6500 8000, 6560 9583
 Fax: 0086-577-6592 2008
 E-mail: info@sort.com.cn

Oversea branches

Global SORL Auto & Truck Parts Inc.(USA)

1200 E. Gene Autry Way
 Anaheim CA 92805
 Tel: 001-714-634 1888
 Fax: 001-714-634 1886
 E-mail: mike@globalsorl.com

Golden Dragon Auto Spare Parts(Dubai)

P.O.Box 56306, Dubai, U.A.E
 Tel: 00971-4-2278556
 Fax: 00971-4-2278552
 E-mail: sorl@emirate.net.ae

Local distributor



SORL Bulgaria Ltd.(Bulgaria)

West Industrial zone
 Ex brewery factory
 9000 Varna, Bulgaria
 Tel: 0035-9899 193801
 E-mail: g.petrov@sort-europe.bg



Power Steering Pumps

2023

Power Steering Pumps





SALES NETWORK





COMPANY PROFILE

Founded in 1987, Ruili Group is mainly specialized in researching & developing, manufacturing and distributing of auto parts and railway vehicle parts, while also runs diversified business including education, hotels and real estate.

Its product lines cover brake system, clutch system, suspension system, steering system, cabin parts, body parts, maintenance parts, etc. The big range of products, manufactured strictly according to national and international standards at plants with a total construction area of 1 million square meter, as well as from its

strategic partners of chain platform, are widely applied in Chinese, European, American, Japanese, Korean, Russian and Indian trucks, buses, trailers and passenger cars.

With over 12,000 employees working at the headquarters, 22 subsidiaries and more than 300 sales branches at home and abroad, Ruili offers excellent service to over 100 OEM and numerous aftermarket customers all around the world. Ruili is the leading manufacturer in its field and is dedicated to continuously satisfy customers and partners worldwide.

HIGH STANDARD MANUFACTURING

One main factor that's contributed to SORL's improvement in quality has been the implementation and use of modern and advanced equipment. SORL is always looking at the latest manufacturing technology and processes in order to continuously improve productivity and quality. Dedicated to 'quality, SORL makes no compromise when delivering new products to a customer, and ensures all products delivered match the customer's specification. SORL products are second to none and meet global quality standards in their class and range of manufacture. In keeping with this, SORL has put in place rigorous quality control procedures to ensure the supply of products are defect free.



Technical Center



Tooling Workshop



Die-Casting Workshop



Stamping Workshop

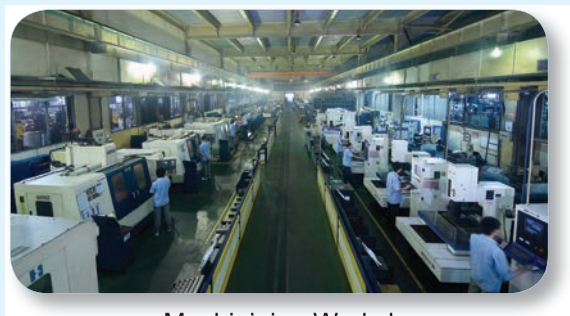

Machining Workshop



Assembly Workshop

QUALITY GUARANTEE

Certificate

Standard IATF 16949:2016
(1st edition, 2016-10-14)

Certificate Registr. No. 01 111 019323
IATF Certificate No. 0399127

Certificate Holder: Ruili Group Ruian Auto Parts Co., Ltd.
No. 2666, Kaifu Avenue, Ruian Development Zone,
325200 Zhejiang, P. R. China
With extended manufacturing site(s) according to annex

Scope: Design and Manufacturing of Air Brake System Components, Hydraulic Brake System Components, Power Steering Pumps, Electric Parts (Switches, Wiper Blade Assembly, Solenoid Valves, Horns, Flashers, Relays and Window Regulators) and Relative Electronic Control Units & Components, Pressure Sensors, Displacement Sensors, Air Flow Sensors, Voice Alarm Terminals and Emission Remote Monitoring Terminals
Proof has been furnished by means of an audit that the requirements of IATF 16949:2016 are met.

Validity: The certificate is valid from 2021-05-14 until 2024-05-13.

Release date: 2021-05-14



2-IAO-QAC 21003



www.tuv.com



China National Accreditation Service for Conformity Assessment
LABORATORY ACCREDITATION CERTIFICATE
(Registration No. CNAS L9790)

Ruili Group Ruian Auto Parts Co., Ltd. Testing Center
(Legal Entity: Ruili Group Ruian Auto Parts Co., Ltd.)
No.2666_Development Zone Road,
Economic Development Zone, Ruian, Zhejiang, China

is accredited in accordance with **ISO/IEC 17025: 2017 General Requirements for the Competence of Testing and Calibration Laboratories**(CNAS-CL01 Accreditation Criteria for the Competence of Testing and Calibration Laboratories) for the competence to undertake the service described in the schedule attached to this certificate.

The scope of accreditation is detailed in the attached schedule bearing the same registration number as above. The schedule forms an integral part of this certificate.

Effective Date: 2023-03-08
Expiry Date: 2029-03-07



Signed on behalf of China National Accreditation Service for Conformity Assessment

China National Accreditation Service for Conformity Assessment (CNAS) is authorized by Certification and Accreditation Administration of the People's Republic of China (CACA) to operate the national accreditation schemes for conformity assessment. CNAS is a signatory of the International Laboratory Accreditation Cooperation Mutual Recognition Arrangement (ILAC-MRA) and the Asia Pacific Accreditation Cooperation Mutual Recognition Arrangement (APAC-MRA). The validity of the certificate can be checked on CNAS website at <http://www.cnas.org.cn/english/index.html>.



CERTIFICATE OF REGISTRATION

This is to certify that the management system of:

Ruili Group Ruian Auto Parts Co., Ltd.
No. 2666, Development Road, Ruian Economic Development Zone, Zhejiang, P. R. China
has been registered by Intertek as conforming to the requirements of:

ISO 45001:2018
The management system is applicable to:
Design, manufacturing and sales of automotive brake system brake components
(Certified to OHSAS 18001:2007 from 09 August 2006 to 24 June 2020)

Unified Social Credit Identifier: 91330381790678354W
Certificate Number: 7384-EX15
Initial Certification Date: 09 August 2020
Date of Certification Decision: 25 May 2021
Issuing Date: 25 May 2021
Valid Until: 30 May 2024



Calin Moldovean
President, Business Assurance
Intertek Certification Limited, 32A Victory Park, Victory Road, Derby DE24 6BZ, United Kingdom
Intertek Certification Limited is a UKAS accredited body under schedule of accreditation no. 024



CERTIFICATE OF REGISTRATION

This is to certify that the management system of:

Ruili Group Ruian Auto Parts Co., Ltd.
No. 2666, Development Road, Ruian Economic Development Zone, Zhejiang, P. R. China
has been registered by Intertek as conforming to the requirements of:

ISO 14001:2015
The management system is applicable to:
Design, manufacturing and sales of automotive brake system brake components

Unified Social Credit Identifier: 91330381790678354W
Certificate Number: 7384-EX15
Initial Certification Date: 19 June 2020
Date of Certification Decision: 25 May 2021
Issuing Date: 25 May 2021
Valid Until: 08 June 2024



Calin Moldovean
President, Business Assurance
Intertek Certification Limited, 32A Victory Park, Victory Road, Derby DE24 6BZ, United Kingdom
Intertek Certification Limited is a UKAS accredited body under schedule of accreditation no. 024



SORL adopts a number of advanced management systems, especially ISO/TS16949 which is specially required by the international auto industry, to control the whole process of production, from designing, manufacturing, packing to aftermarket service, ensuring the stability and consistency of products. Recently the company is actively bringing in Six Sigma Management to achieve further improvement.

CONTENTS

AMERICAN APPLICATION

BUICK	01
CATEL	01
CHEROKEE	01-02
CHEVROLET	02-03
CHRYSLER	03-04
CUMMINS	04-05
DODGE	05-06
FORD	07-11
GMC	11-15
HOLDEN	15-16
PETERBILT	16
OTHER VEHICLE SERIES	16-18

EUROPEAN APPLICATION

DAF	19
FIAT	19
IVECO	20-21
LAND ROVER	21
MAN	21-24
MERCEDES BENZ	24-30
SCANIA	31-33
VOLKSWAGEN	33-34
VOLVO	35-38

CHINESE APPLICATION

ANHUI TIANLI	62
CAMXC	63
BEIBEN TRUCK	63-64
BEIQI FOTON	64-65
BYD	65
CHANGSHA FOTON	66-68
DCD	68
CDW	69
CHONGQING LIFAN	69
YEMA AUTO	70
DONGFENG	70
FAW	71-73
HENGWEI	73
ANKAI	73-74
GAC GONOW	74
HAWTAI	74-75
GEELY	75
JAC	76
JINBEI	76
SINOTRUCK	76

JAPANESE APPLICATION

HINO	38-40
HONDA	40-41
INFINITI	41-42
ISUZU	42-44
MITSUBISHI	44-45
NISSAN	45-47
SUBARU	47
SUZUKI	48
TOYOTA	48-52

KOREAN APPLICATION

AMW	58
DAEWOO	53-55
HYUNDAI	56-58
KIA	58

INDIAN APPLICATION

AMW	58
ASHOK LEYLAND	59
EICHER	59
MAHINDRA	60
TATA	60-62

LIUZHOU WULIN	76
NANHAI FOTON	77
CHERY	77-79
QUANCHAI	79
SHACMAN	79
WUZHOU LONG	79
SFC	80
KINGLONG	80-81
XICHA FAW	81-85
WEI CHAI	85-88
YANGDONG	88
YC DIESEL	88-89
YUNAN LIFAN	89-90
YUNNEI	90
ZXAUTO	90
ZHUCHENG FOTON	90-92

GEAR PUMP SERIES

GEAR PUMP	93-96
-----------	-------



BUICK



Drawing No.: **3407 08131 001**
Repair Kit:

Displacement: 8.2ml/r
Controlled flow: 8.5L/min
Max. pressure: 11.5MPa
Speed range: 400-7000r/min
Rotation: R
Fuel feed hole: Φ 21
Fuel discharge hole: M16 \times 1.5

Cross Ref: 13582209
Application: Buick/Cadillac 2010-2017



CHEROKEE



SORL No.: **YBZ09-085/090**
Drawing No.: **3407 0901 001**
Repair Kit: **3407 0901 900**

Displacement: 9.3ml/r
Controlled flow: 8.5L/min
Max. pressure: 9MPa
Speed range: 500-7000r/min
Rotation: R
Fuel feed hole: 7/8-14UNF
Fuel discharge hole: M16 \times 1.5

Application: Cherokee



SORL No.: **3407 1278 001**

Displacement: 12.3ml/r
Controlled flow: 11.7L/min
Max. pressure: 9.5MPa
Speed range: 400-7000r/min
Rotation: R
Fuel feed hole: Φ 10
Fuel discharge hole: 5/8-18UNF
Cross Ref: 96-6176

Application: BUICK,PONTIAC
74-71,Family Type: GM Small Threaded



SORL No.: **YBZ09A-085/090**
Drawing No.: **3407 0902 001**
Repair Kit: **3407 0902 900**

Displacement: 9.3ml/r
Controlled flow: 8.5L/min
Max. pressure: 9MPa
Speed range: 500-7000r/min
Rotation: R
Fuel feed hole: Φ 19.4
Fuel discharge hole: M16 \times 1.5

Application: Cherokee



CATEL



SORL No.: **YBZ11F-100/180**
Drawing No.: **3407 1105 001**
Repair Kit: **3407 1105 900**

Displacement: 10.8ml/r
Controlled flow: 16L/min
Max. pressure: 13MPa
Speed range: 400-7000r/min
Rotation: R
Fuel feed hole: Φ 10
Fuel discharge hole: M20 \times 1.5

Cross Ref.: 52089300AA,
52009300AB
Application: Jeep



SORL No.: **YBZ16C1A-190/140L**
Drawing No.: **3407 1617 001**
Repair Kit: **3407 1617 900**

Displacement: 16ml/r
Controlled flow: 19L/min
Max. pressure: 14MPa
Speed range: 500-4000r/min
Rotation: L
Fuel feed hole: M30 \times 2
Fuel discharge hole: M20 \times 1.5

Application: CAT3126



Drawing No.: **3407 1178 001**
Repair Kit: **3407 1178 900**

Displacement: 11ml/r
Controlled flow: 9.2L/min
Max. pressure: 9.8MPa
Speed range: 400-8000r/min
Rotation: R
Fuel feed hole: Φ 19.4
Fuel discharge hole: M16 \times 1.5

Application: Jeep



Drawing No.: **3407 1308 001**
Repair Kit.: **3407 1308 900**

Displacement: 12.7ml/r
Controlled flow: 18.5L/min
Max. pressure: 14.5MPa
Speed range: 400-8000r/min
Rotation: R
Fuel feed hole: $\Phi 19$
Fuel discharge hole: M20 \times 1.5

Cross Ref.: 52089883AC
Application: Jeep



SORL No.: **3407 09138 001**

Controlled flow: 9.7L/min
Max.pressure: 9.5MPa
Speed range: 400~7000r/min
Rotation: R
Fuel feed hole: $\Phi 10$
Fuel discharge hole: M16 \times 1.5
Cross Ref: 96-7926

Application:PONTIAC,
CHEVROLET 92-82
Family Type: GM Small Metric



SORL No.: **3407 1276 001**

Displacement: 12.3ml/r
Controlled flow: 10.2L/min
Max.pressure: 10MPa
Speed range: 400~7000r/min
Rotation: R
Fuel feed hole: $\Phi 10$
Fuel discharge hole: M16 \times 1.5
Cross Ref: 96-7940

Application: CHEV,GMC 91-89
Family Type: GM Small Metric



Drawing No.: **3407 0758 001**
Repair Kit.:

Displacement: 7.2ml/r
Controlled flow: 6L/min
Max. pressure: 8MPa
Speed range: 400-6000r/min
Rotation: R
Fuel feed hole: $\Phi 17.5$
Fuel discharge hole: M16 \times 1.5

Cross Ref: 26418 94704486
Application: Chevrolet Celta VHC/
AGILE 1.4 09



SORL No.: **3407 1280 001**

Displacement: 12.3ml/r
Controlled flow: 11.7L/min
Max.pressure: 9.5MPa
Speed range: 400~7000r/min
Rotation: R
Fuel feed hole: $\Phi 10$
Fuel discharge hole: 5/8-18UNF
Cross Ref: 96-6094

Application: CHEVROLET 1968
Family Type: GM SMALL THREADED



Drawing No.: **3407 08129 001**
Repair Kit.:

Displacement: 8.2ml/r
Controlled flow: 7.2L/min
Max. pressure: 11MPa
Speed range: 400-7000r/min
Rotation: R
Fuel feed hole: $\Phi 21$
Fuel discharge hole: M16 \times 1.5

Cross Ref: 13505832
AAZ 13576570
Application: Chevrolet Camaro 2010-2015



SORL No.: **3407 0730 001**

Displacement: 7ml/r
Controlled flow: 5.2L/min
Max.pressure: 7MPa
Speed range: 400~7000r/min
Rotation: R
Fuel feed hole: $\Phi 15.2$
Fuel discharge hole: M16 \times 1.5

Cross Ref: 21-5896,49100-56B00
Application: 1995-1990 Trucks Asuna,
Chevrolet,Geo,GMC,Pontiac,SUZUKI



Drawing No.: **3407 11170 001**
Repair Kit.:

Displacement: 11ml/r
Controlled flow: 7.1L/min
Max. pressure: 12MPa
Speed range: 400-7000r/min
Rotation: R
Fuel feed hole: $\Phi 11$
Fuel discharge hole: M16 \times 1.5

Cross Ref: 92229662
Application: CHEVROLET, CAMARO 6.2L
V8(2010-2012)/6.2L V8 Supercharged



SORL No.: **3407 09133 001**

Displacement: 8.8ml/r
Controlled flow: 4.5L/min
Max.pressure: 7MPa
Speed range: 400~7000r/min
Rotation: R
Fuel feed hole: $\Phi 14.5$
Fuel discharge hole: M16 \times 1.5

Cross Ref: 96-5168,44320-02034
Application: CHEVROLET,
TOYOTA 02-98



Displacement: 12.3ml/r
 Controlled flow: 9.7L/min
 Max.pressure: 10MPa
 Speed range: 400~7000r/min
 Rotation: R
 Fuel feed hole: Φ10
 Fuel discharge hole: M16×1.5
 Cross Ref: 96-7886

Application:
 CHEVROLET,CORVETTE 81-80

SORL No.: **3407 1290 001**



Displacement: 8.2ml/r
 Controlled flow: 7.5L/min
 Max. pressure: 10.3MPa
 Speed range: 400-8000r/min
 Rotation: R
 Fuel feed hole: Φ14.5
 Fuel discharge hole: M16×1.5

Application: 01-07 Chrysler
 Town & Country
 01-0 7Chrysler Trucks Voyager

SORL No.: **YBZ08E-070/095**
 Drawing No.: **3407 0804 001**
 Repair Kit.: **3407 0804 900**



Displacement: 14.7ml/r
 Controlled flow: 11.9L/min
 Max.pressure: 9.5MPa
 Speed range: 400~7000r/min
 Rotation: R
 Fuel feed hole: Φ10
 Fuel discharge hole: 5/8-18UNF
 Cross Ref: 96-6901

Application: PONTIAC 79-77
 Family Type: GM Small Metric

SORL No.: **3407 1279 001**



Displacement: 9.4ml/r
 Controlled flow: 7.2L/min
 Max. pressure: 10MPa
 Speed range: 400-7000r/min
 Rotation: R
 Fuel feed hole: Φ16
 Fuel discharge hole: M16×1.5
 Cross Ref.: 4684158, 4684156
 Application: 00-00 Chrysler Grand Voyager
 96-00 Chrysler Town & Country
 97-00 Chrysler Voyager

Drawing No.: **3407 0912 001**
 Repair Kit.: **3407 0912 900**

Displacement: 8.8ml/r
 Controlled flow: 7L/min
 Max. pressure: 9.5MPa
 Speed range: 400-8000r/min
 Rotation: R
 Fuel feed hole: Φ14.5
 Fuel discharge hole: M16×1.5

Cross Ref.: 4656402AC,
 4656402AE, 4656402AD
 Application: 01-02 Chrysler PT Cruiser

Drawing No.: **3407 0921 001**
 Repair Kit.: **3407 0921 900**



Displacement: 8.2ml/r
 Controlled flow: 6.8L/min
 Max.pressure: 10MPa
 Speed range: 500~6000r/min
 Rotation: R
 Fuel feed hole: Φ19.2
 Fuel discharge hole: M16×1.5
 Cross Ref: 6245

Application: 2007-2004Chrysler Trucks
 Voyager,2007-2001Dodge Trucks Caravan

SORL No.: **3407 08121 001**



Displacement: 8.8ml/r
 Controlled flow: 6L/min
 Max. pressure: 9.5MPa
 Speed range: 400-8000r/min
 Rotation: R
 Fuel feed hole: Φ14.5
 Fuel discharge hole: M16×1.5

Drawing No.: **3407 0922 001**
 Repair Kit.: **3407 0922 900**



Displacement: 12.4ml/r
 Controlled flow: 6.8L/min
 Max.pressure: 10MPa
 Speed range: 400~7000r/min
 Rotation: R
 Fuel feed hole: Φ16
 Fuel discharge hole: M16×1.5
 Cross Ref:
 96-8759,4743063AA,4743969AA

Application: CHRYSLER,
 DODGE TRKS 02-01

SORL No.: **3407 1284 001**

Cross Ref.:
 5272780AD, 5273760AC,
 5272313AI, 5272313AD,
 5272313AF, 5272929AB,
 5273759AA, 5272313AG,
 5272313AE, 5272929AA,
 5272929AC, 5273759AJ
 Application: 03-10 Chrysler PT Cruiser

Pictures And/Or OEM Part Numbers are for reference purpose only.



SORL No.: **3407 16562 001**

Displacement: 16.2ml/r
 Controlled flow: 9.5L/min
 Max.pressure: 6.5MPa
 Speed range: 500~6000r/min
 Rotation: R
 Fuel feed hole: Φ9
 Fuel discharge hole: 5/8-18UNF
 Cross Ref: 96-6184

Application: CHRY FAMILY 76-63



SORL No.: **3407 16616 001**

Displacement: 16.2ml/r
 Controlled flow: 9.5L/min
 Max.pressure: 6.5MPa
 Speed range: 500~6000r/min
 Rotation: R
 Fuel feed hole: Φ9
 Fuel discharge hole: 5/8-18UNF

Cross Ref: 20-130
 Application: CHRY FAMILY 76-63



SORL No.: **YBZ16C2-190/140**
 Drawing No.: **3407 1618 001**
 Repair Kit: **3407 1618 900**

Displacement: 16.7ml/r
 Controlled flow: 19L/min
 Max. pressure: 14MPa
 Speed range: 500-3200r/min
 Rotation: R
 Fuel feed hole: M30x2
 Fuel discharge hole: M20x1.5

Cross Ref.: 3406NDL-010
 Application: Cummins 6BT

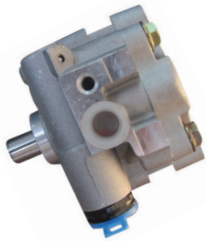

Drawing No.: **3407 1023 001**
 Repair Kit: **3407 1023 900**

Displacement: 9.6ml/r
 Controlled flow: 7.8L/min
 Max. pressure: 11.5MPa
 Speed range: 400-8000r/min
 Rotation: R
 Fuel feed hole: Φ19
 Fuel discharge hole: M16x1.5

Application: 05-10 Chrysler 300



SORL No.: **YBZ16C2A-190/140**
 Drawing No.: **3407 1619 001**
 Repair Kit: **3407 1619 900**

Displacement: 16.7ml/r
 Controlled flow: 19L/min
 Max. pressure: 14MPa
 Speed range: 500-3200r/min
 Rotation: R
 Fuel feed hole: M30x2
 Fuel discharge hole: M20x1.5

Cross Ref.: 3406NDL-010
 Application: Cummins 6BT



SORL No.: **YBZ11A1-090/090**
 Drawing No.: **3407 1103 001**
 Repair Kit: **3407 1103 900**

Displacement: 10.9ml/r
 Controlled flow: 9L/min
 Max. pressure: 9MPa
 Speed range: 500-8000r/min
 Rotation: R
 Fuel feed hole: Φ14.5
 Fuel discharge hole: M16x1.5

Cross Ref.: 4782146AC,
 4782207AC, 4782207AD
 Application: 98-04 Chrysler Concorde
 98-04 Chrysler Intrepid (Canada)



SORL No.: **YBZ16C5-190/140**
 Drawing No.: **3407 1622 001**
 Repair kit: **3407 1622 900**

Displacement: 16.7ml/r
 Controlled flow: 19L/min
 Max. pressure: 14MPa
 Speed range: 500-3200r/min
 Rotation: R
 Fuel feed hole: NPT1
 Fuel discharge hole: 3/4-16UNF

Cross Ref.: V10F1P5T38D5H
 Application: Cummins



SORL No.: **YBZ14C4-130/120**
 Drawing No.: **3407 1409 001**
 Repair Kit: **3407 1409 900**

Displacement: 14.5ml/r
 Controlled flow: 13L/min
 Max. pressure: 12MPa
 Speed range: 500-7000r/min
 Rotation: R
 Fuel feed hole: Φ16
 Fuel discharge hole: M16x1.5

Cross Ref.: 68034303AB,
 68044144AC
 Application: Chrysler



SORL No.: **YBZ16C5A-190/140**
 Drawing No.: **3407 1623 001**
 Repair kit: **3407 1623 900**

Displacement: 16.7ml/r
 Controlled flow: 19L/min
 Max. pressure: 14MPa
 Speed range: 500-3200r/min
 Rotation: R
 Fuel feed hole: NPT1
 Fuel discharge hole: 3/4-16UNF

Cross Ref.: V10NF1P5S38D5H
 Application: Cummins



Displacement: 16.7ml/r
Controlled flow: 19L/min
Max. pressure: 14MPa
Speed range: 500-3200r/min
Rotation: R
Fuel feed hole: 1-5/6-12 UN
Fuel discharge hole: 3/4-16UNF

SORL No.: **YBZ16C5B-190/140**
Drawing No.: **3407 1624 001**
Repair kit: **3407 1624 900**

Cross Ref.: V10F1S5P38C5H
Application: Cummins



Displacement: 8.2ml/r
Controlled flow: 7.5L/min
Max. pressure: 10.3MPa
Speed range: 400-8000r/min
Rotation: R
Fuel feed hole: Φ 14.5
Fuel discharge hole: M16 \times 1.5

SORL No.: **YBZ08E-070/095**
Drawing No.: **3407 0804 001**
Repair kit: **3407 0804 900**

Application: 01-07 Dodge Caravan



Displacement: 16.7ml/r
Controlled flow: 19L/min
Max. pressure: 14MPa
Speed range: 500-3200r/min
Rotation: R
Fuel feed hole: NPT1
Fuel discharge hole: 3/4-16UNF

SORL No.: **YBZ16C5C-190/140**
Drawing No.: **3407 1625 001**
Repair Kit.: **3407 1625 900**

Cross Ref.: V10F1P5P38C5H
Application: Cummins



Displacement: 8.2ml/r
Controlled flow: 6.4L/min
Max. pressure: 9MPa
Speed range: 400-8000r/min
Rotation: R
Fuel feed hole: Φ 14.5
Fuel discharge hole: M16 \times 1.5

Drawing No.: **3407 0841 001**
Repair Kit.: **3407 0841 900**

Application: 01-06 Dodge Stratus



Displacement: 20.6ml/r
Controlled flow: 19L/min
Max. pressure: 12.5MPa
Speed range: 500-3200r/min
Rotation: R
Fuel feed hole: 1-5/16-12UN
Fuel discharge hole: 3/4-16 UNF

SORL No.: **YBZ20CA-190/125**
Drawing No.: **3407 2010 001**
Repair Kit.: **3407 2010 900**

Cross Ref.: V10NF1S6T38C5G
Application: Cummins



Displacement: 8.8ml/r
Controlled flow: 6L/min
Max. pressure: 9.5MPa
Speed range: 400-6000r/min
Rotation: R
Fuel feed hole: Φ 14.5
Fuel discharge hole: M16 \times 1.5

Drawing No.: **3407 0922 001**
Repair Kit.: **3407 0922 900**

Application: 03-05 Dodge Neon



DODGE

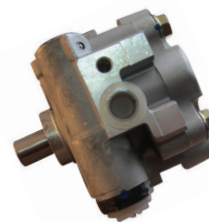

Displacement: 9.6ml/r
Controlled flow: 10L/min
Max. pressure: 11.5MPa
Speed range: 400-7000r/min
Rotation: R
Fuel feed hole: Φ 14.5
Fuel discharge hole: M16 \times 1.5

Drawing No.: **3407 1022 001**
Repair Kit.: **3407 1022 900**

Cross Ref.: 52855186AC/AE
Application: 05-07 Dodge Dakota



Displacement: 13ml/r
Controlled flow: 8.7L/min
Max. pressure: 8.25MPa
Speed range: 400-7000r/min
Rotation: R
Fuel feed hole: Φ 9.5
Fuel discharge hole: M16 \times 1.5
Cross Ref.: 63263,21-4045,
52106253AD,AE,AF
Application: DOKOTA 4.7L
2000-2001,DURANGO

SORL No.: **3407 1349 001**

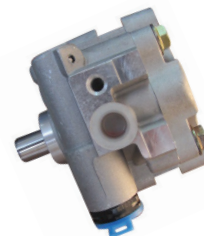

Displacement: 9.6ml/r
Controlled flow: 7.8L/min
Max. pressure: 11.5MPa
Speed range: 400-8000r/min
Rotation: R
Fuel feed hole: Φ 19
Fuel discharge hole: M16 \times 1.5
Application:

Drawing No.: **3407 1023 001**
Repair Kit.: **3407 1023 900**

09-10 Dodge Challenger
06-10 Dodge Charger
05-08 Dodge Magnum



Displacement: 10.9ml/r
Controlled flow: 9L/min
Max. pressure: 9MPa
Speed range: 500-8000r/min
Rotation: R
Fuel feed hole: Φ 14.5
Fuel discharge hole: M16 \times 1.5

SORL No.: **YBZ11A1-090/090**
Drawing No.: **3407 1103 001**
Repair Kit.: **3407 1103 900**

Cross Ref.: 4782146AC,
4782207AC, 4782207AD
Application: 98-04 Dodge Intrepid



Displacement: 13ml/r
Controlled flow: 8.7L/min
Max. pressure: 8.25MPa
Speed range: 400-8000r/min
Rotation: R
Fuel feed hole: Φ 14.5
Fuel discharge hole: M16 \times 1.5

Drawing No.: **3407 1309 001**
Repair Kit.: **3407 1309 900**

Application: 00-04 Dodge Dakota
00-03 Dodge Durango



Displacement: 11.5ml/r
Controlled flow: 10L/min
Max. pressure: 10MPa
Speed range: 400-8000r/min
Rotation: R
Fuel feed hole: Φ 19
Fuel discharge hole: M16 \times 1.5

Drawing No.: **3407 1155 001**
Repair Kit.: **3407 1155 900**

Application: 07-11 Dodge Nitro



Displacement: 14.5ml/r
Controlled flow: 11.8L/min
Max. pressure: 12.5MPa
Speed range: 400-7000r/min
Rotation: R
Fuel feed hole: Φ 19
Fuel discharge hole: M16 \times 1.5

Drawing No.: **3407 1426 001**
Repair Kit.: **3407 1426 900**

Application: Dodge-ram 2500
Truck, ram 3500 Truck(09-03)



Displacement: 12.3ml/r
Controlled flow: 9.6L/min
Max. pressure: 9.5MPa
Speed range: 400-7000r/min
Rotation: R
Fuel feed hole: Φ 10
Fuel discharge hole: M16 \times 1.5
Cross Ref.: 52007104,
52039173, 52039489AB
Application: 92-96 Dodge Van
92-93 Dodge Pickup

Drawing No.: **3407 1206 001**
Repair Kit.: **3407 1206 900**



Displacement: 14.5ml/r
Controlled flow: 11L/min
Max. pressure: 11MPa
Speed range: 400-7000r/min
Rotation: R
Fuel feed hole: Φ 19
Fuel discharge hole: M16 \times 1.5
Cross Ref.: 52113364AE,
52113364AK, 52113454AI,
52113454AK
Application: Dodge-RAM 1500

Drawing No.: **3407 1427 001**
Repair Kit.: **3407 1427 900**



Displacement: 13ml/r
Controlled flow: 9L/min
Max. pressure: 8MPa
Speed range: 500-8000r/min
Rotation: R
Fuel feed hole: Φ 9.5
Fuel discharge hole: M16 \times 1.5

SORL No.: **YBZ13-090/080**
Drawing No.: **3407 1301 001**
Repair Kit.: **3407 1301 900**

Application: 00-04 Dodge Dakota
00-03 Dodge Durango



Displacement: 15ml/r
Controlled flow: 12.5L/min
Max. pressure: 10MPa
Speed range: 400-7000r/min
Rotation: R
Fuel feed hole: Φ 10
Fuel discharge hole: M16 \times 1.5

Drawing No.: **3407 1525 001**
Repair Kit.: **3407 1525 900**

Cross Ref.: 52037606, 52039489
Application: 94-03 Dodge Truck



Displacement: 13ml/r
Controlled flow: 9L/min
Max. pressure: 10MPa
Speed range: 500-8000r/min
Rotation: R
Fuel feed hole: Φ 14.5
Fuel discharge hole: M16 \times 1.5

SORL No.: **YBZ13A-090/080**
Drawing No.: **3407 1302 001**
Repair Kit.: **3407 1302 900**

Application: 00-04 Dodge Dakota
00-03 Dodge Durango



Displacement: 14.5ml/r
Controlled flow: 11.8L/min
Max. pressure: 12.5MPa
Speed range: 400-7000r/min
Rotation: R
Fuel feed hole: Φ 19
Fuel discharge hole: M16 \times 1.5

Drawing No.: **3407 1526 001**
Repair Kit.: **3407 1526 900**

Application: Dodge-ram 2500
Truck, ram 3500 Truck(09-03)



Displacement: 9ml/r
 Controlled flow: 7.5L/min
 Max. pressure: 6.3MPa
 Speed range: 400-7000r/min
 Rotation: R
 Fuel feed hole: $\Phi 18$
 Fuel discharge hole: M16 \times 1.5

 Cross Ref.: YS4Z 3A674-AERM,
 1M5Z 3A674-AARM
 Application: 00-03 Ford Focus

Drawing No.: **3407 0924 001**
 Repair Kit.: **3407 0924 900**



Displacement: 9ml/r
 Controlled flow: 7L/min
 Max. pressure: 6.5MPa
 Speed range: 500-7000r/min
 Rotation: R
 Fuel feed hole: $\Phi 18$
 Fuel discharge hole: $\Phi 9.7$

SORL No.: **YBZ09C-070/065**
 Drawing No.: **3407 0903 001**
 Repair Kit.: **3407 0903 900**

Application: Ford



Displacement: 9ml/r
 Controlled flow: 7.6L/min
 Max. pressure: 7MPa
 Speed range: 400-6000r/min
 Rotation: R
 Fuel feed hole: $\Phi 19$
 Fuel discharge hole: 5/8-18UNF
 Application: 65-65 Ford Country Sedan
 65-65 Ford Country Squire
 65-65 Ford Custom/ Ford Fairlane
 65-65 Ford Falcon/ Ford Galaxie
 65-65 Ford LTD (Full Size)
 65-65 /65-65 Ford Ranch Wagon
 65-65 Ford Ranchero/Mercury Comet
 65-65 Mercury Cyclone
 58-65Ford Thunderbird
 58-64Ford Pickup
 58-79Ford Trucks - Medium Duty B500/B600
 /C500/C550/C600/C700/F700/F750/LN600
 /N500/N600/N700/N850
 61-64 Mercury Colony Park
 58-64 Mercury Commuter/Mercury Park Lane
 63-64Mercury Marauder
 58-64Mercury Montclair /Mercury Monterey

Drawing No.: **3407 0957 001**
 Repair Kit.: **3407 0957 900**



Displacement: 9ml/r
 Controlled flow: 6L/min
 Max. pressure: 10MPa
 Speed range: 500-7000r/min
 Rotation: R
 Fuel feed hole: $\Phi 20$
 Fuel discharge hole: M16 \times 1.5

Drawing No.: **3407 09114 001**
 Repair Kit.:

Cross Ref: 2S65-3A696-DA
 Application: FORD ECOSPORT / FIESTA



Displacement: 11.3ml/r
 Controlled flow: 8L/min
 Max. pressure: 9MPa
 Speed range: 500-7000r/min
 Rotation: R
 Fuel feed hole: $\Phi 20$
 Fuel discharge hole: M16 \times 1.5

Drawing No.: **3407 09122 001**
 Repair Kit.:

Cross Ref: 2S55-3A696-AA
 2S65-3A696-AA
 Application: FORD KA 1.0/1.6 ROCAM



Displacement: 9ml/r
 Controlled flow: 7.6L/min
 Max. pressure: 7MPa
 Speed range: 400-6000r/min
 Rotation: R
 Fuel feed hole: $\Phi 19$
 Fuel discharge hole: 5/8-18UNF

Drawing No.: **3407 0958 001**
 Repair Kit.: **3407 0958 900**

Application:
 65-65Ford Country Sedan
 /Ford Country Squire/Ford Ranchero
 /Ford Custom /Ford Fairlane
 /Ford Falcon /Ford Galaxie
 /Ford LTD (Full Size)
 /Ford Mustang /Ford Ranch Wagon
 /Ford Thunderbird/Mercury Comet
 61-64Mercury Colony Park
 65-65Mercury Cyclone
 63-64Mercury Marauder
 58-64Mercury Montclair
 /Mercury Monterey
 /Mercury Commuter
 /Mercury Park Lane



Displacement: 9.6ml/r
 Controlled flow: 6L/min
 Max. pressure: 9MPa
 Speed range: 400-8000r/min
 Rotation: R
 Fuel feed hole: $\Phi 14$
 Fuel discharge hole: M16 \times 1.5
 Cross Ref.: V2388140490,
 YL843D639BD,
 YL8Z 3A674-AARM
 Application: 01-04 Ford Escape

Drawing No.: **3407 0919 001**
 Repair Kit.: **3407 0919 900**

Pictures And/Or OEM Part Numbers are for reference purpose only.



Drawing No.: **3407 0929 001**
Repair Kit.: **3407 0929 900**

Displacement: 9ml/r
Controlled flow: 13L/min
Max. pressure: 10MPa
Speed range: 400-7000r/min
Rotation: R
Fuel feed hole: $\Phi 16$
Fuel discharge hole: M16 \times 1.5
Cross Ref.: 2L1Z 3A674-FARM,
2L1Z 3A674-GBRM
Application: 03-09 Ford Expedition
07-09 Lincoln Navigator



SORL No.: **YBZ14C-100/085**
Drawing No.: **3407 1405 001**
Repair Kit.: **3407 1405 900**

Displacement: 14.5ml/r
Controlled flow: 10.6L/min
Max. pressure: 9MPa
Speed range: 400-7000r/min
Rotation: R
Fuel feed hole: $\Phi 18$
Fuel discharge hole: M16 \times 1.5
Cross Ref.: 3C3Z 3A674-AARM
Application: 97-07 Ford Super Duty



Drawing No.: **3407 0959 001**
Repair Kit.: **3407 0959 900**

Displacement: 9ml/r
Controlled flow: 7.6L/min
Max. pressure: 7MPa
Speed range: 400-6000r/min
Rotation: R
Fuel feed hole: $\Phi 19$
Fuel discharge hole: 5/8-18UNF

Application:
62-78Ford Trucks - Medium Duty



Drawing No.: **3407 1131 001**
Repair Kit.: **3407 1131 900**

Displacement: 11.2ml/r
Controlled flow: 8.2L/min
Max. pressure: 8.5MPa
Speed range: 400-7000r/min
Rotation: R
Fuel feed hole: $\Phi 16$
Fuel discharge hole: M16 \times 1.5

Cross Ref.: 19131873
Application: Ford



Drawing No.: **3407 1119 001**
Repair Kit.: **3407 1119 900**

Displacement: 11.3ml/r
Controlled flow: 11L/min
Max. pressure: 9.5MPa
Speed range: 500-7000r/min
Rotation: R
Fuel feed hole: $\Phi 10$
Fuel discharge hole: M16 \times 1.5

Cross Ref.: BA3A674A
Application: Ford Falcon



SORL No.: **YBZ14C2-100/090**
Drawing No.: **3407 1407 001**
Repair Kit.: **3407 1407 900**

Displacement: 14.5ml/r
Controlled flow: 10.6L/min
Max. pressure: 9MPa
Speed range: 400-7000r/min
Rotation: R
Fuel feed hole: $\Phi 16$
Fuel discharge hole: M16 \times 1.5

Cross Ref.: F85C-3A674-AARM
Application: 01-02 Ford Expedition
97-07 Ford Pickup
99-02 Mercury Grand Marquis
Police/Fleet/Taxi



SORL No.: **YBZ14C1-100/085**
Drawing No.: **3407 1406 001**
Repair Kit.: **3407 1406 900**

Displacement: 14.5ml/r
Controlled flow: 10L/min
Max. pressure: 9MPa
Speed range: 400-7000r/min
Rotation: R
Fuel feed hole: $\Phi 16$
Fuel discharge hole: M16 \times 1.5

Cross Ref.: XW7Z-3A674-ABRM,
F8AZ 3A674-CARM
Application: 92-02 Ford Crown
93-02 Ford Grand Marquis (Mexico)
96-01Ford Expedition
91-02 Lincoln Town Car
02-03 Lincoln Blackwood
98-02 Lincoln Navigator
92-02 Mercury Grand Marquis



SORL No.: **YBZ14C3-080/100**
Drawing No.: **3407 1408 001**
Repair Kit.: **3407 1408 900**

Displacement: 14.5ml/r
Controlled flow: 7.7L/min
Max. pressure: 9.5MPa
Speed range: 400-7000r/min
Rotation: R
Fuel feed hole: $\Phi 18$
Fuel discharge hole: M16 \times 1.5

Cross Ref.: 1F2C-3A674-BBRM
Application: 99-03 Ford Windstar



Drawing No.: **3407 1429 001**
Repair Kit.: **3407 1429 900**

Displacement: 14.5ml/r
Controlled flow: 10.6L/min
Max. pressure: 9MPa
Speed range: 400-7000r/min
Rotation: R
Fuel feed hole: $\Phi 18$
Fuel discharge hole: M16 \times 1.5

Cross Ref.: XW4Z3A674GARM,
XW4Z 3A674-GBRM
Application: Ford/Lincoln



Drawing No.: **3407 1431 001**
Repair Kit.: **3407 1431 900**

Displacement: 14.5ml/r
Controlled flow: 10.6L/min
Max. pressure: 9MPa
Speed range: 500-7000r/min
Rotation: R
Fuel feed hole: $\Phi 18$
Fuel discharge hole: M16 \times 1.5

Cross Ref.: 2L7Z3A674BAR
Application: Ford Expedition/Lincoln



SORL No.: **YBZ15D-100/100**
Drawing No.: **3407 1510 001**
Repair Kit.: **3407 1510 900**

Displacement: 14.7ml/r
Controlled flow: 10L/min
Max. pressure: 10MPa
Speed range: 500-7000r/min
Rotation: R
Fuel feed hole: $\Phi 11$
Fuel discharge hole: M16 \times 1.5

Cross Ref.: 25188044
Application: Ford



Drawing No.: **3407 1433 001**
Repair Kit.: **3407 1433 900**

Displacement: 14.5ml/r
Controlled flow: 7.7L/min
Max. pressure: 9.5MPa
Speed range: 400-7000r/min
Rotation: R
Fuel feed hole: $\Phi 18$
Fuel discharge hole: M16 \times 1.5

Application: Ford



Drawing No.: **3407 1550 001**
Repair Kit.: **3407 1550 900**

Displacement: 14.7ml/r
Controlled flow: 11L/min
Max. pressure: 8.3MPa
Speed range: 400-6000r/min
Rotation: R
Fuel feed hole: $\Phi 9.5$
Fuel discharge hole: 5/8-18UNF

Cross Ref.: D3AZ3A674A,
D4AZ3A674A, D6TZ3A674A,
D3AZ3A674B, D4OZ3A674A,
D6TZ3A674C
Application: 75 Ford Bronco
67-74 Ford Country Sedan, Squire,
Pickup, 67 Ford Galaxie
67-72 Ford Custom, Thunderbird
67-77 Ford Custom 500
75-77 Ford F-100, F-150, F-250,
F-350, F-500
72-76 Ford Gran Torino
77 Ford LTD II, Thunderbird
72-74 Ford Ranch Wagon/Ranchero
75-77 Mercury Grand Marquis
70-71 Lincoln Continental, Mark III
67-68 Mercury Commuter, Montclair,
Park lane
74-77 Mercury Cougar



Drawing No.: **3407 1434 001**
Repair Kit.: **3407 1434 900**

Displacement: 14.5ml/r
Controlled flow: 11L/min
Max. pressure: 9MPa
Speed range: 400-7000r/min
Rotation: R
Fuel feed hole: $\Phi 16$
Fuel discharge hole: M16 \times 1.5

Application: Ford



Drawing No.: **3407 1435 001**
Repair Kit.: **3407 1435 900**

Displacement: 14.5ml/r
Controlled flow: 10.6L/min
Max. pressure: 10MPa
Speed range: 400-7000r/min
Rotation: R
Fuel feed hole: $\Phi 18$
Fuel discharge hole: M16 \times 1.5

Application: Ford



Drawing No.: **3407 1556 001**
Repair Kit.: **3407 1556 900**

Displacement: 14.7ml/r
Controlled flow: 11L/min
Max. pressure: 8.3MPa
Speed range: 400-6000r/min
Rotation: R
Fuel feed hole: $\Phi 9.5$
Fuel discharge hole: 5/8-18UNF

Application: 67-70 Ford Fairlane,
Falcon, Mustang,
Mercury Cougar
70-74 Ford Maverick, Ranch
Wagon, Ranchero,
F-250 Pickup, F-350 Pickup,
Galaxie 500, Colony Park,
Monterey
68-71 Ford Torino,
Mercury Montego
67-69 Mercury Comet, Cyclone
71-74 Mercury Comet



Drawing No.: **3407 1444 001**
Repair Kit.: **3407 1444 900**

Displacement: 14.5ml/r
Controlled flow: 10L/min
Max. pressure: 8MPa
Speed range: 400-7000r/min
Rotation: R
Fuel feed hole: $\Phi 16$
Fuel discharge hole: M16 \times 1.5

Cross Ref.: XW7Z-3A673-ABRM
Application: Ford



Displacement: 14.7ml/r
Controlled flow: 11L/min
Max. pressure: 8.3MPa
Speed range: 400-7000r/min
Rotation: R
Fuel feed hole: $\Phi 19$
Fuel discharge hole: 5/8-18UNF

Drawing No.: **3407 15116 001**
Repair Kit.:
Application: FORD FAMILY CAR/
TRK 58-66



Displacement: 21ml/r
Controlled flow: 16L/min
Max. pressure: 15MPa(Without)
Speed range: 500-3600r/min
Rotation: R
Fuel feed hole: M26×1.5
Fuel discharge hole: M16×1.5

Drawing No.: **3407 21100 001**
Repair Kit.: **3407 21100 900**
Cross Ref.: 7674 955 306
Application: Ford Bmcpro



Displacement: 14.7ml/r
Controlled flow: 11L/min
Max. pressure: 8.3MPa
Speed range: 400-6000r/min
Rotation: R
Fuel feed hole: $\Phi 9.5$
Fuel discharge hole: 5/8-18UNF
Application: 70 Ford Falcon Sprint
75-76 Ford Granada/Mercury Monarch
71-76 Ford Maverick/Mercury Comet,
70 Ford Mustang, Mustang II
70-70 Mercury Cougar,

Drawing No.: **3407 1555 001**
Repair Kit.: **3407 1555 900**



Displacement: 21ml/r
Controlled flow: 17L/min
Max. pressure: 15MPa(Without)
Speed range: 500-3600r/min
Rotation: R
Fuel feed hole: $\Phi 19$
Fuel discharge hole: 3/4-16UNF-2A
Cross Ref.: TJG145157, 7674 975 923
Application: Ford Cargo 1617/1621/
Cargo 1622/1630/ Cargo 1716/1721/
Cargo 1722/1731/ Cargo 4030

Drawing No.: **3407 2133 001**
Repair Kit.: **3407 2133 900**



Displacement: 14.7ml/r
Controlled flow: 11L/min
Max. pressure: 8.3MPa
Speed range: 400-6000r/min
Rotation: R
Fuel feed hole: $\Phi 9.5$
Fuel discharge hole: 5/8-18UNF

Drawing No.: **3407 1561 001**
Repair Kit.: **3407 1561 900**
Application: 71-77 Ford/Mercury
Cars & Truck



Displacement: 9.4ml/r
Controlled flow: 9.7L/min
Max. pressure: 8.5MPa
Speed range: 400-7000r/min
Rotation: R
Fuel feed hole: $\Phi 10$
Fuel discharge hole: 5/8-18UNF

SORL No.: **3407 09140 001**
Cross Ref: 96-6086
Application: FORD, MAZDA,
MERC TRK 07-05



Displacement: 14.7ml/r
Controlled flow: 11L/min
Max. pressure: 8.3MPa
Speed range: 400-6000r/min
Rotation: R
Fuel feed hole:
Fuel discharge hole: 3/8-18UNF

Drawing No.: **3407 1576 001**
Repair Kit.: **3407 1576 900**
Application: Ford



Displacement: 11.2ml/r
Controlled flow: 9.1L/min
Max. pressure: 10MPa
Speed range: 400-7000r/min
Rotation: R
Fuel feed hole: $\Phi 18$
Fuel discharge hole: M16×1.5

SORL No.: **3407 11310 001**
Cross Ref: 90-343,
8G1Z3A674A, 63199
Application: FORD TAURUS 3.5L V6 2008



Displacement: 21ml/r
Controlled flow: 16L/min
Max. pressure: 13MPa
Speed range: 500-3600r/min
Rotation: R
Fuel feed hole: M26×1.5
Fuel discharge hole: M16×1.5

SORL No.: **YBZ21A-160/130**
Drawing No.: **3407 2103 001**
Repair Kit.: **3407 2103 900**
Cross Ref.: 7674 955 245
Application: Ford Devfatih



Displacement: 11.2ml/r
Controlled flow: 9.5L/min
Max. pressure: 10MPa
Speed range: 500-6000r/min
Rotation: R
Fuel feed hole: $\Phi 16$
Fuel discharge hole: M16×1.5

SORL No.: **3407 14127 001**
Cross Ref: 7297, 20-312,
2L7Z3A674BARM
Application: 08-04 Ford Trucks

Pictures And/Or OEM Part Numbers are for reference purpose only.



Displacement: 14.5ml/r
 Controlled flow: 9.8L/min
 Max.pressure: 9MPa
 Speed range: 500~6000r/min
 Rotation: R
 Fuel feed hole: Φ16
 Fuel discharge hole: M16×1.5

Cross Ref: 7129,20-282
 Application: 2002-1999Ford Crown Victoria,Police,Fleet,Taxi

SORL No.: **3407 14141 001**



Displacement: 8.5ml/r
 Controlled flow: 5L/min
 Max. pressure: 5.5MPa
 Speed range: 500-7000r/min
 Rotation: R
 Fuel feed hole: Φ16
 Fuel discharge hole: M16×1.5

SORL No.: **YBZ08S-050/055**
 Drawing No.: **3407 0827 001**
 Repair Kit.: **3407 0827 900**

Cross Ref.: 93249438
 Application: SAIL



Displacement: 14.5ml/r
 Controlled flow: 9.5L/min
 Max.pressure: 9.5MPa
 Speed range: 500~6000r/min
 Rotation: R
 Fuel feed hole: Φ18
 Fuel discharge hole: M16×1.5

Cross Ref:96-291,2L1Z3A674FARM, 7L1Z3A674A
 Application: FORD,LINC TPK 09-07

SORL No.: **3407 14168 001**



Displacement: 8.3ml/r
 Controlled flow: 5L/min
 Max. pressure: 6MPa
 Speed range: 500-7000r/min
 Rotation: R
 Fuel feed hole: Φ16
 Fuel discharge hole: M16×1.5

SORL No.: **YBZ08S1-050/055**
 Drawing No.: **3407 0828 001**
 Repair Kit.: **3407 0828 900**

Cross Ref.: 93249438
 Application: SAIL Saibao



Displacement: 14.7ml/r
 Controlled flow: 11L/min
 Max.pressure: 8.3MPa
 Speed range: 400~7000r/min
 Rotation: R
 Fuel feed hole: Φ9.5
 Fuel discharge hole: 5/8-18UNF

Cross Ref: 96-6092
 Application: CAR,TRK 58-66

SORL No.: **3407 15116 001**



Displacement: 8.8ml/r
 Controlled flow: 7.8L/min
 Max. pressure: 10MPa
 Speed range: 500-7000r/min
 Rotation: R
 Fuel feed hole: Φ14
 Fuel discharge hole: M16×1.5

Drawing No.: **3407 0846 001**
 Repair Kit.: **3407 0846 900**

Cross Ref.: 19195037
 Application: GM



Displacement: 14.7ml/r
 Controlled flow: 11.8L/min
 Max.pressure: 8.8MPa
 Speed range: 500~6000r/min
 Rotation: R
 Fuel feed hole: -
 Fuel discharge hole: 5/8-18UNF

Cross Ref: 96-232
 Application: FORD FAMILY Ford Large Thompson

SORL No.: **3407 15148 001**



Displacement: 9ml/r
 Controlled flow: 8L/min
 Max. pressure: 8.5MPa
 Speed range: 400-7000r/min
 Rotation: R
 Fuel feed hole: Φ10
 Fuel discharge hole: M16×1.5

Drawing No.: **3407 0915 001**
 Repair Kit.: **3407 0915 900**

Cross Ref.: 26031276, 26041722, 26043370, 26046846, 26048008, 26086097
 Application: 94-96 Buick Century 03-04 Oldsmobile Alero 97-99 Oldsmobile Cutlass 99-05 Pontiac Grand Am 01-01 Pontiac Trucks Aztek 99-03 Pontiac Trucks Montana 96-98 Pontiac Trucks Trans Sport





Displacement: 9ml/r
 Controlled flow: 10.9L/min
 Max. pressure: 8.5MPa
 Speed range: 400-7000r/min
 Rotation: R
 Fuel feed hole: $\Phi 10$
 Fuel discharge hole: M16 \times 1.5
 Cross Ref.: 26046847, 26043369, 88985332
 Application: 97-03 Buick Century
 96-97 Buick Regal/Oldsmobile
 Cutlass Supreme
 96-02 Pontiac Grand Prix

Drawing No.: **3407 0914 001**
 Repair Kit.: **3407 0914 900**



Displacement: 11ml/r
 Controlled flow: 7.5L/min
 Max. pressure: 7.5MPa
 Speed range: 500-7000r/min
 Rotation: R
 Fuel feed hole: $\Phi 16$
 Fuel discharge hole: M16 \times 1.5

SORL No.: **YBZ11NM-075/075**
 Drawing No.: **3407 1110 001**
 Repair Kit.: **3407 1110 900**

Cross Ref.: 25187904/NM1580
 Application: GM



Displacement: 9ml/r
 Controlled flow: 8L/min
 Max. pressure: 10MPa
 Speed range: 400-7000r/min
 Rotation: R
 Fuel feed hole: $\Phi 10$
 Fuel discharge hole: M16 \times 1.5

Drawing No.: **3407 0916 001**
 Repair Kit.: **3407 0916 900**

Cross Ref.: 26035305
 Application: 96-02 Buick LeSabre
 96-99 Buick Park Avenue
 96-96 Buick Regal
 95-96 Buick Riviera
 95-96 Oldsmobile 98
 95-99 Oldsmobile Delta 88
 96-99 Oldsmobile LSS
 97-98 Oldsmobile Regency
 95-02 Pontiac Bonneville



Displacement: 11ml/r
 Controlled flow: 8L/min
 Max. pressure: 12MPa
 Speed range: 500-7000r/min
 Rotation: R
 Fuel feed hole: $\Phi 19.4$
 Fuel discharge hole: M16 \times 1.5

Drawing No.: **3407 1124 001**
 Repair Kit.: **3407 1124 900**

Cross Ref.: 40461
 Application: 01-02 Oldsmobile Aurora



Displacement: 11ml/r
 Controlled flow: 8.7L/min
 Max. pressure: 9.5MPa
 Speed range: 500-7000r/min
 Rotation: R
 Fuel feed hole: $\Phi 19.4$
 Fuel discharge hole: M16 \times 1.5

Drawing No.: **3407 1125 001**
 Repair Kit.: **3407 1125 900**

Cross Ref.: 431361
 Application: 01-02 Oldsmobile Intrigue



Displacement: 8.8ml/r
 Controlled flow: 5L/min
 Max. pressure: 7MPa
 Speed range: 400-7000r/min
 Rotation: R
 Fuel feed hole: $\Phi 14.5$
 Fuel discharge hole: M16 \times 1.5

Drawing No.: **3407 0945 001**
 Repair Kit.: **3407 0945 900**

Cross Ref.: 948558906
 Application: 98-00 Chevrolet
 Prizm



Displacement: 11.3ml/r
 Controlled flow: 7.8L/min
 Max. pressure: 11.9MPa
 Speed range: 400-8000r/min
 Rotation: R
 Fuel feed hole: $\Phi 19.4$
 Fuel discharge hole: M16 \times 1.5
 Cross Ref.: 26073311, 26083495, 88955485
 Application: 01-03 Oldsmobile Aurora
 04-05 Pontiac Bonneville
 98-05 Cadillac DeVille
 98-04 Cadillac Seville

Drawing No.: **3407 1135 001**
 Repair Kit.: **3407 1135 900**



Displacement: 11ml/r
 Controlled flow: 7.5L/min
 Max. pressure: 7.5MPa
 Speed range: 500-7000r/min
 Rotation: R
 Fuel feed hole: $\Phi 16$
 Fuel discharge hole: M16 \times 1.5

SORL No.: **YBZ11NH-075/075**
 Drawing No.: **3407 1109 001**
 Repair Kit.: **3407 1109 900**

Cross Ref.: 25187890/NH1134
 Application: GM



Displacement: 15ml/r
 Controlled flow: 12L/min
 Max. pressure: 10MPa
 Speed range: 400-7000r/min
 Rotation: R
 Fuel feed hole: $\Phi 10$
 Fuel discharge hole: M16 \times 1.5

SORL No.: **YBZ15D1-110/100**
 Drawing No.: **3407 1511 001**
 Repair Kit.: **3407 1511 900**

Application: 70-74 Chevrolet Monte Carlo



Displacement: 15ml/r
Controlled flow: 12.5L/min
Max. pressure: 10MPa
Speed range: 500-7000r/min
Rotation: R
Fuel feed hole: Φ 10
Fuel discharge hole: M16 \times 1.5

SORL No.: **YBZ15D2-110/100**
Drawing No.: **3407 1512 001**
Repair Kit.: **3407 1512 900**

Application: GM



Displacement: 15ml/r
Controlled flow: 12.5L/min
Max. pressure: 10MPa
Speed range: 400-7000r/min
Rotation: R
Fuel feed hole: Φ 17
Fuel discharge hole: M16 \times 1.5

SORL No.: **YBZ15D2C-110/100**
Drawing No.: **3407 1517 001**
Repair Kit.: **3407 1517 900**

Cross Ref.: 26069038,26057293
Application: GM



Displacement: 15ml/r
Controlled flow: 12.5L/min
Max. pressure: 10MPa
Speed range: 400-7000r/min
Rotation: R
Fuel feed hole: Φ 10
Fuel discharge hole: M16 \times 1.5

Drawing No.: **3407 1513 001**
Repair Kit.: **3407 1513 900**

Application: GM



Displacement: 15ml/r
Controlled flow: 12.5L/min
Max. pressure: 8MPa
Speed range: 500-7000r/min
Rotation: R
Fuel feed hole: Φ 10
Fuel discharge hole: M16 \times 1.5

Drawing No.: **3407 1520 001**
Repair Kit.: **3407 1520 900**

Application: GM



Repair kit: 3407 1514 900
Displacement: 15ml/r
Controlled flow: 12.5L/min
Max. pressure: 10MPa
Speed range: 400-7000r/min
Rotation: R
Fuel feed hole: Φ 10
Fuel discharge hole: M16 \times 1.5

SORL No.: **YBZ15D2A-110/100**
Drawing No.: **3407 1514 001**
Repair Kit.: **3407 1514 900**

Cross Ref.: 26081016
Application: GM



Displacement: 15ml/r
Controlled flow: 10L/min
Max. pressure: 10MPa
Speed range: 500-7000r/min
Rotation: R
Fuel feed hole: Φ 10
Fuel discharge hole: M16 \times 1.5

Drawing No.: **3407 1521 001**
Repair Kit.: **3407 1521 900**

Application: GM



Displacement: 15ml/r
Controlled flow: 12.5L/min
Max. pressure: 10MPa
Speed range: 400-7000r/min
Rotation: R
Fuel feed hole: Φ 10
Fuel discharge hole: M16 \times 1.5

SORL No.: **YBZ15D2B-110/100**
Drawing No.: **3407 1515 001**
Repair Kit.: **3407 1515 900**

Cross Ref.: 26037446
Application: GM



Displacement: 15ml/r
Controlled flow: 10.6L/min
Max. pressure: 9.5MPa
Speed range: 400-7000r/min
Rotation: R
Fuel feed hole: Φ 10
Fuel discharge hole: M16 \times 1.5

Drawing No.: **3407 1523 001**
Repair Kit.: **3407 1523 900**

Cross Ref.: 26003871, 26008897
Application: GM



Displacement: 15ml/r
Controlled flow: 10.6L/min
Max. pressure: 9.5MPa
Speed range: 400-7000r/min
Rotation: R
Fuel feed hole: Φ 10
Fuel discharge hole: M16 \times 1.5
Cross Ref.:
26015764, 26015767, 26020019,
26020020, 26025302, 26037445

SORL No.: **YBZ15D2C-110/100**
Drawing No.: **3407 1516 001**
Repair Kit.: **3407 1516 900**

Application: GM



Displacement: 15ml/r
Controlled flow: 12.5L/min
Max. pressure: 10MPa
Speed range: 400-7000r/min
Rotation: R
Fuel feed hole: Φ 10
Fuel discharge hole: M16 \times 1.5
Cross Ref.: 26021138, 26042247,
26022616, 26057289

Drawing No.: **3407 1524 001**
Repair Kit.: **3407 1524 900**

Application: GM

Pictures And/Or OEM Part Numbers are for reference purpose only.

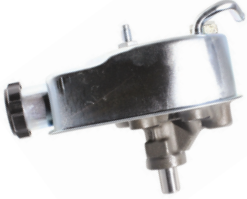

Displacement: 15ml/r
Controlled flow: 12.5L/min
Max. pressure: 10MPa
Speed range: 400-7000r/min
Rotation: R
Fuel feed hole: $\Phi 10$
Fuel discharge hole: M16 \times 1.5

Drawing No.: **3407 1527 001**
Repair Kit.: **3407 1527 900**

Application: GM



Displacement: 15ml/r
Controlled flow: 12.5L/min
Max. pressure: 10MPa
Speed range: 400-7000r/min
Rotation: R
Fuel feed hole: $\Phi 10$
Fuel discharge hole: M16 \times 1.5

Drawing No.: **3407 1532 001**
Repair Kit.: **3407 1532 900**

Application: GM



Displacement: 15ml/r
Controlled flow: 12.5L/min
Max. pressure: 10MPa
Speed range: 400-7000r/min
Rotation: R
Fuel feed hole: $\Phi 10$
Fuel discharge hole: M16 \times 1.5

Drawing No.: **3407 1528 001**
Repair Kit.: **3407 1528 900**

Application: GM



Displacement: 15ml/r
Controlled flow: 12.5L/min
Max. pressure: 10MPa
Speed range: 400-7000r/min
Rotation: R
Fuel feed hole: $\Phi 10$
Fuel discharge hole: M16 \times 1.5

Drawing No.: **3407 1533 001**
Repair Kit.: **3407 1533 900**

Cross Ref.: 7839787
Application: GM



Displacement: 15ml/r
Controlled flow: 12.5L/min
Max. pressure: 10MPa
Speed range: 400-7000r/min
Rotation: R
Fuel feed hole: $\Phi 10$
Fuel discharge hole: M16 \times 1.5

Drawing No.: **3407 1529 001**
Repair Kit.: **3407 1529 900**

Cross Ref.: 26070099
Application: GM



Displacement: 15ml/r
Controlled flow: 12L/min
Max. pressure: 9.7MPa
Speed range: 400-7000r/min
Rotation: R
Fuel feed hole: $\Phi 16$
Fuel discharge hole: M16 \times 1.5

Drawing No.: **3407 1535 001**
Repair Kit.: **3407 1535 900**

Application: GM



Displacement: 15ml/r
Controlled flow: 10.6L/min
Max. pressure: 9.5MPa
Speed range: 400-7000r/min
Rotation: R
Fuel feed hole: $\Phi 10$
Fuel discharge hole: M16 \times 1.5

Drawing No.: **3407 1530 001**
Repair Kit.: **3407 1530 900**

Cross Ref.: 15076611, 15134700,
15909834, 15077397, 15270264,
15909830, 15909834, 20756710
Application: GM



Displacement: 15ml/r
Controlled flow: 12.5L/min
Max. pressure: 10MPa
Speed range: 400-7000r/min
Rotation: R
Fuel feed hole: $\Phi 10$
Fuel discharge hole: M16 \times 1.5

Drawing No.: **3407 1544 001**
Repair Kit.: **3407 1544 900**

Application: GM



Displacement: 15ml/r
Controlled flow: 12.5L/min
Max. pressure: 10MPa
Speed range: 400-7000r/min
Rotation: R
Fuel feed hole: $\Phi 10$
Fuel discharge hole: M16 \times 1.5

Drawing No.: **3407 1531 001**
Repair Kit.: **3407 1531 900**

Application: GM



Displacement: 15ml/r
Controlled flow: 8L/min
Max. pressure: 8MPa
Speed range: 500-7000r/min
Rotation: R
Fuel feed hole: $\Phi 16$
Fuel discharge hole: M16 \times 1.5

Drawing No.: **3407 1545 001**
Repair Kit.: **3407 1545 900**

Application: GM

Pictures And/Or OEM Part Numbers are for reference purpose only.



Displacement: 14.7ml/r
 Controlled flow: 10.6L/min
 Max. pressure: 9.5MPa
 Speed range: 400-7000r/min
 Rotation: R
 Fuel feed hole: $\Phi 10$
 Fuel discharge hole: M16 \times 1.5

Drawing No.: **3407 1546 001**
 Repair Kit.: **3407 1546 900**

Application: GM



Displacement: 10.8ml/r
 Controlled flow: 9.3L/min
 Max. pressure: 9.5MPa
 Speed range: 400~7000r/min
 Rotation: R
 Fuel feed hole: $\Phi 9.8$
 Fuel discharge hole: M16 \times 1.5

SORL No.: **3407 09142 001**

Cross Ref: 96-38606
 Application: JEEP 95-91



Displacement: 14.7ml/r
 Controlled flow: 10.6L/min
 Max. pressure: 9.5MPa
 Speed range: 400-7000r/min
 Rotation: R
 Fuel feed hole: $\Phi 10$
 Fuel discharge hole: M16 \times 1.5

Drawing No.: **3407 1547 001**
 Repair Kit.: **3407 1547 900**

Application: GM



Displacement: 14.7ml/r
 Controlled flow: 11.9L/min
 Max. pressure: 9.5MPa
 Speed range: 400~7000r/min
 Rotation: R
 Fuel feed hole: $\Phi 10$
 Fuel discharge hole: M16 \times 1.5

SORL No.: **3407 1281 001**

Cross Ref: 96-7879
 Application: AMC, JEEP 91-80
 Family Type: GM Small Metric



Displacement: 19ml/r
 Controlled flow: 8L/min
 Max. pressure: 9MPa
 Speed range: 400-3200r/min
 Rotation: R
 Fuel feed hole: $\Phi 10$
 Fuel discharge hole: M16 \times 1.5
 Cross Ref.: 26028227,
 26038090, 26039433,
 26039660, 26047567, 26091879

Drawing No.: **3407 1902 001**
 Repair Kit.: **3407 1902 900**

Application: GM



Displacement: 12.3ml/r
 Controlled flow: 8.3L/min
 Max. pressure: 10MPa
 Speed range: 400~7000r/min
 Rotation: R
 Fuel feed hole: $\Phi 10$
 Fuel discharge hole: M16 \times 1.5

SORL No.: **3407 1282 001**

Cross Ref: 96-8301
 Application:



Displacement: 20ml/r
 Controlled flow: 22.5L/min
 Max. pressure: 12.5MPa
 Speed range: 500-3200r/min
 Rotation: R
 Fuel feed hole: 1-5/16-12UN
 Fuel discharge hole: NPT3/4

SORL No.: **YBZ20C3B-225/125**
 Drawing No.: **3407 2009 001**
 Repair Kit.: **3407 2009 900**

Cross Ref.: 5838 08C91
 V20NF1D6P38C6G20

Application: GM



HOLDEN



Displacement: 9.4ml/r
 Controlled flow: 8.3L/min
 Max. pressure: 9.5MPa
 Speed range: 400~7000r/min
 Rotation: R
 Fuel feed hole: $\Phi 10$
 Fuel discharge hole: M16 \times 1.5

SORL No.: **3407 09137 001**

Cross Ref: 96-7911
 Application: JEEP, GM FAMILY 87-80
 Family Type: GM Small Metric

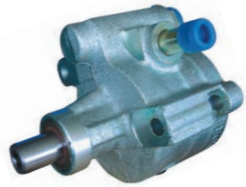

Displacement: 15ml/r
 Controlled flow: 8L/min
 Max. pressure: 8MPa
 Speed range: 500-7000r/min
 Rotation: R
 Fuel feed hole: $\Phi 16$
 Fuel discharge hole: M16 \times 1.5

SORL No.: **YBZ15C1-080/080**
 Drawing No.: **3407 1507 001**
 Repair Kit.: **3407 1507 900**

Cross Ref.: 25188038
 Application: Holden



Displacement: 15ml/r
 Controlled flow: 8L/min
 Max. pressure: 10MPa
 Speed range: 500-7000r/min
 Rotation: R
 Fuel feed hole: Φ 19
 Fuel discharge hole: M16 \times 1.5

SORL No.: **YBZ15C2-080/080**
 Drawing No.: **3407 1508 001**
 Repair Kit.: **3407 1508 900**

Cross Ref.: 25188039
 Application: Holden



Displacement: 20.5ml/r
 Controlled flow: 22.5L/min
 Max. pressure: 12.5MPa
 Speed range: 500-3200r/min
 Rotation: R
 Fuel feed hole: 1- 1/4NPT
 Fuel discharge hole: 3/4-16UNF

SORL No.: **YBZ20C3-225/125**
 Drawing No.: **3407 2028 001**
 Repair Kit.: **3407 2028 900**

Cross Ref.: V20F1P6P38C6G11
 Application: Peterbilt



Displacement: 15ml/r
 Controlled flow: 8L/min
 Max. pressure: 8MPa
 Speed range: 500-7000r/min
 Rotation: R
 Fuel feed hole: Φ 10
 Fuel discharge hole: M16 \times 1.5

SORL No.: **YBZ15D-080/080**
 Drawing No.: **3407 1509 001**
 Repair Kit.: **3407 1509 900**

Cross Ref.: 25188041
 Application: Holden



Displacement: 20.5ml/r
 Controlled flow: 22.5L/min
 Max. pressure: 10.5MPa
 Speed range: 500-3200r/min
 Rotation: R
 Fuel feed hole: NPT1
 Fuel discharge hole: 3/4-16UNF

SORL No.: **YBZ20C-225/105**
 Drawing No.: **3407 2029 001**
 Repair Kit.: **3407 2029 900**

Cross Ref.: V10F1P6P38D6F
 Application: Peterbilt 10-01724

Displacement: 20.5ml/r
 Controlled flow: 22.5L/min
 Max. pressure: 12.5MPa
 Speed range: 500-3200r/min
 Rotation: R
 Fuel feed hole: NPT1
 Fuel discharge hole: 3/4-16UNF

SORL No.: **YBZ20C-225/125**
 Drawing No.: **3407 2035 001**
 Repair Kit.: **3407 2035 900**

Cross Ref.: V10F1P6P38D6G
 Application: Peterbilt 10-01724



Displacement: 16ml/r
 Controlled flow: 19L/min
 Max. pressure: 12.5MPa
 Speed range: 500-3200r/min
 Rotation: R
 Fuel feed hole: NPT 1
 Fuel discharge hole: 3/4-16UNF

Drawing No.: **3407 1675 001**
 Repair Kit.: **3407 1675 900**

Cross Ref.: V10F1P5P11A5G20
 Application: Peterbilt

Displacement: 20.5ml/r
 Controlled flow: 22.5L/min
 Max. pressure: 14MPa
 Speed range: 500-3200r/min
 Rotation: R
 Fuel feed hole: NPT1
 Fuel discharge hole: 3/4-16 UNF

SORL No.: **YBZ20C-225/140**
 Drawing No.: **3407 2001 001**
 Repair Kit.: **3407 2001 900**

Cross Ref.: V10F1P6P38D6H
 Application: Peterbilt10-01724



Displacement: 11ml/r
 Controlled flow: 11L/min
 Max. pressure: 13MPa
 Speed range: 500-4800r/min
 Rotation: L
 Fuel feed hole: Φ 20
 Fuel discharge hole: 3/4-16UNF

Drawing No.: **3407 11144 001**
 Repair Kit.:

Cross Ref: 2P0115105A



Displacement: 11ml/r
 Controlled flow: 8.5L/min
 Max. pressure: 10MPa
 Speed range: 500-4800r/min
 Rotation: L
 Fuel feed hole: $\Phi 17.5$
 Fuel discharge hole: M16 \times 1.5

Drawing No.: **3407 1137 001**
 Repair Kit.:

Cross Ref: 7002661C1



Displacement: 21ml/r
 Controlled flow: 14L/min
 Max. pressure: 15MPa
 Speed range: 500-3600r/min
 Rotation: L
 Fuel feed hole: 1-5/16-12UN
 Fuel discharge hole: 3/4-16UNF

Drawing No.: **3407 2190 001**
 Repair Kit.: **3407 2190 900**

Cross Ref.: 1682625C91,
 542 0176 10
 Application: DINA



Displacement: 21ml/r
 Controlled flow: 22.5L/min
 Max. pressure: 15MPa
 Speed range: 500-3600r/min
 Rotation: R
 Fuel feed hole: 1-5/16-12UN
 Fuel discharge hole: 3/4-16UNF

Drawing No.: **3407 2186 001**
 Repair Kit.: **3407 2186 900**

Cross Ref.: 2106438, 2106749,
 542 0248 10
 Application: KENWORTH



Displacement: 21ml/r
 Controlled flow: 15L/min
 Max. pressure: 16.5MPa
 Speed range: 500-3600r/min
 Rotation: R
 Fuel feed hole: 1-1/16-12UN
 Fuel discharge hole: 3/4-16UNF

Drawing No.: **3407 2191 001**
 Repair Kit.: **3407 2191 900**

Cross Ref.: 2005337C91,
 542 0320 10
 Application: INTERNATIONAL



Displacement: 25ml/r
 Controlled flow: 25L/min
 Max. pressure: 16.5MPa
 Speed range: 500-3600r/min
 Rotation: R
 Fuel feed hole: 1-1/16-12UN
 Fuel discharge hole: 3/4-16UNF

Drawing No.: **3407 2187 001**
 Repair Kit.: **3407 2187 900**

Cross Ref.: 3538860C91,
 542 0267 10
 Application: INTERNATIONAL



Displacement: 29.7ml/r
 Controlled flow: 34L/min
 Max. pressure: 16MPa
 Speed range: 500-3200r/min
 Rotation: R
 Fuel feed hole: NPT 1-1/4
 Fuel discharge hole: 3/4-16UNF-2B

Drawing No.: **3407 2808 001**
 Repair Kit.:

Cross Ref: V20F1P9P38C6G11
 Vickers:416927
 Application: American Other Vehicle Series



Displacement: 21ml/r
 Controlled flow: 14L/min
 Max. pressure: 16MPa
 Speed range: 500-3600r/min
 Rotation: L
 Fuel feed hole: 1-5/16-12UN
 Fuel discharge hole: 3/4-16UNF

Drawing No.: **3407 2188 001**
 Repair Kit.: **3407 2188 900**

Cross Ref.: 226H050040,
 542 0191 10



Displacement: 21ml/r
 Controlled flow: 18L/min
 Max. pressure: 16.5MPa
 Speed range: 500~3600r/min
 Rotation: L
 Fuel feed hole: 1 1/16-12UN
 Fuel discharge hole: 3/4-16UNF

SORL No.: **3407 21181 001**

Cross Ref: 7674 955 343
 Application:



Displacement: 21ml/r
 Controlled flow: 15L/min
 Max. pressure: 15MPa
 Speed range: 500-3600r/min
 Rotation: L
 Fuel feed hole: 1-1/16-12UN
 Fuel discharge hole: 3/4-16UNF

Drawing No.: **3407 2189 001**
 Repair Kit.: **3407 2189 900**

Cross Ref.: 22H050080,
 542 0172 10
 Application: DINA



Displacement: 21ml/r
 Controlled flow: 18L/min
 Max. pressure: 16.5MPa
 Speed range: 500~3600r/min
 Rotation: R
 Fuel feed hole: 1 1/16-12UN
 Fuel discharge hole: 3/4-16UNF

SORL No.: **3407 21182 001**

Cross Ref: 7674 955 344

Pictures And/Or OEM Part Numbers are for reference purpose only.



SORL No.: **3407 21184 001**

Displacement: 21ml/r
Controlled flow: 16L/min
Max.pressure: 13MPa
Speed range: 500~3600r/min
Rotation: L
Fuel feed hole: 1 1/16-12UN
Fuel discharge hole: 3/4-16UNF

Cross Ref: 7674 955 913
Application:



SORL No.: **3407 2550 001**

Displacement: 25ml/r
Controlled flow: 26.5L/min
Max.pressure: 15MPa
Speed range: 500~3600r/min
Rotation: L
Fuel feed hole: M26×1.5
Fuel discharge hole: M18×1.5

Cross Ref: HEMA PL250007M



SORL No.: **3407 18109 001**

Displacement: 18ml/r
Controlled flow: 16L/min
Max.pressure: 15MPa
Speed range: 500~3600r/min
Rotation: L
Fuel feed hole: 1 1/16-12UN
Fuel discharge hole: 3/4-16UNF

Cross Ref: PEV1816-15L101
Application:



SORL No.: **3407 21179 001**

Displacement: 21ml/r
Controlled flow: 16L/min
Max.pressure: 16.5MPa
Speed range: 500~3600r/min
Rotation: L
Fuel feed hole: 1 1/16-12UN
Fuel discharge hole: 3/4-16UNF

Cross Ref: 7674 955 343,
K S01 001 417
Application:



SORL No.: **3407 2411 001**

Displacement: 24ml/r
Controlled flow: 16L/min
Max.pressure: 15MPa
Speed range: 500~3600r/min
Rotation: L
Fuel feed hole: 1 1/16-12UN
Fuel discharge hole: 3/4-16UNF

Cross Ref: PEV251615L101
Application:



SORL No.: **3407 2540 001**

Displacement: 25ml/r
Controlled flow: 16L/min
Max.pressure: 18.5Mpa
Speed range: 500~3600r/min
Rotation: L
Fuel feed hole: 1 5/16-12UN
Fuel discharge hole: 3/4-16UNF

Cross Ref: 3623641C94
Application:



SORL No.: **3407 17176 001**

Displacement: 17.5ml/r
Controlled flow: 16L/min
Max.pressure: 0MPa
Speed range: 500~3600r/min
Rotation: R
Fuel feed hole: M26×1.5
Fuel discharge hole: M18×1.5

Cross Ref:
Application: PAZ-320425-04,
M3 with the YAMZ



SORL No.: **3407 2543 001**

Displacement: 25ml/r
Controlled flow: 25L/min
Max.pressure: 10MPa
Speed range: 500~3600r/min
Rotation: L
Fuel feed hole: M26×1.5
Fuel discharge hole: M18×1.5

Cross Ref: HEMA PL250005M
Application:



Drawing No.: **3407 1065 001**
Repair Kit.: **3407 1065 900**

Displacement: 11ml/r
Controlled flow: 7.4L/min
Max. pressure: 13MPa
Speed range: 400-6000r/min
Rotation: R
Fuel feed hole: M18×1.5
Fuel discharge hole: M14×1.5

Application: 94-01BMW E38
95-01BMW 730, 735, 740



Displacement: 17ml/r
Controlled flow: 14L/min
Max. pressure: 13MPa
Speed range: 500-3600r/min
Rotation: L
Fuel feed hole: M26×1.5
Fuel discharge hole: M18×1.5

Drawing No.: **3407 1784 001**
Repair Kit.: **3407 1784 900**

Cross Ref.: 7673 955 227
Application: DAF



Displacement: 14ml/r
Controlled flow: 16L/min
Max. pressure: 15MPa(Without)
Speed range: 500-3600r/min
Rotation: L
Fuel feed hole: M26×1.5
Fuel discharge hole: M18×1.5

Drawing No.: **3407 1420 001**
Repair Kit.: **3407 1420 900**

Cross Ref.: 7672 955 287,
8001 449, 3000272
Application: DAF



Displacement: 17ml/r
Controlled flow: 16L/min
Max. pressure: 10MPa
Speed range: 500-3600r/min
Rotation: L
Fuel feed hole: M26×1.5
Fuel discharge hole: M18×1.5

Drawing No.: **3407 1785 001**
Repair Kit.: **3407 1785 900**

Cross Ref.: 7673 955 217,
647602
Application: DAF

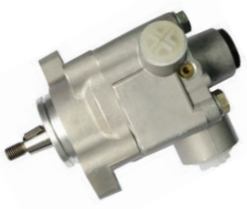

Displacement: 14ml/r
Controlled flow: 16L/min
Max. pressure: 15MPa(Without)
Speed range: 500-3600r/min
Rotation: L
Fuel feed hole: M26×1.5
Fuel discharge hole: M18×1.5

Drawing No.: **3407 1450 001**
Repair Kit.: **3407 1450 900**

Cross Ref.: 1291227, 1239411,
542 0014 10
Application: DAF 95



Displacement: 17ml/r
Controlled flow: 16L/min
Max. pressure: 15MPa(Without)
Speed range: 500-3600r/min
Rotation: L
Fuel feed hole: M26×1.5
Fuel discharge hole: ZM18

SORL No.: **YBZ16F1-160L**
Drawing No.: **3407 1715 001**
Repair Kit.: **3407 1715 900**

Application: DAF



Displacement: 7.2ml/r
Controlled flow: 7L/min
Max. pressure: 8MPa
Speed range: 400-6000r/min
Rotation: R
Fuel feed hole: Φ17.5
Fuel discharge hole: M16×1.5

Drawing No.: **3407 0759 001**
Repair Kit.:

Cross Ref: FIAT 46 541 004
LANCIA 46 413 332
Application: MAREA(185)



Displacement: 17ml/r
Controlled flow: 16L/min
Max. pressure: 15MPa(Without)
Speed range: 500-3600r/min
Rotation: L
Fuel feed hole: M26×1.5
Fuel discharge hole: M18×1.5

Drawing No.: **3407 1783 001**
Repair Kit.: **3407 1783 900**

Cross Ref.: 7674 955 207,
624702
Application: DAF



Displacement: 7.4ml/r
Controlled flow: 6.5L/min
Max. pressure: 11MPa
Speed range: 400-7000r/min
Rotation: R
Fuel feed hole: Φ19
Fuel discharge hole: M16×1.5

Drawing No.: **3407 0761 001**
Repair Kit.:

Cross Ref: ZF 7612 955 125
FIAT 5801525984
Application: DUCATO Platform/chassis

Pictures And/Or OEM Part Numbers are for reference purpose only.



Displacement: 17ml/r
 Controlled flow: 18L/min
 Max. pressure: 15MPa(Without)
 Speed range: 500-3600r/min
 Rotation: L
 Fuel feed hole: M26×1.5
 Fuel discharge hole: M18×1.5
 Cross Ref.: 483 3411, 481 900,
 470 9321, 7673 955 322,
 7673 955 201, 7673 955 314,
 8001 461
 Application: 84-93 Iveco Turbostar
 90-93 Iveco Turbotech

Drawing No.: **3407 1794 001**
 Repair Kit.: **3407 1794 900**



Displacement: 15ml/r
 Controlled flow: 12L/min
 Max. pressure: 12MPa
 Speed range: 500-3000r/min
 Rotation: R
 Fuel feed hole: M26×1.5
 Fuel discharge hole: M18×1.5

SORL No.: **YBZ15A1-120/120**
 Drawing No.: **3407 1503 001**
 Repair Kit.: **3407 1503 900**

Cross Ref.: 7672 955 253
 Application: Iveco



Displacement: 17ml/r
 Controlled flow: 16L/min
 Max. pressure: 15MPa(Without)
 Speed range: 500-3600r/min
 Rotation: L
 Fuel feed hole: M26×1.5
 Fuel discharge hole: M18×1.5
 Cross Ref.: 483 1152,
 7673 955 294, 8001 459
 Application: 93-02 Iveco Eurostar
 92- Iveco Eurotech MP
 93-04 Iveco Eurotrakker

Drawing No.: **3407 1795 001**
 Repair Kit.: **3407 1795 900**



Displacement: 17ml/r
 Controlled flow: 16L/min
 Max. pressure: 15MPa(Without)
 Speed range: 500-3900r/min
 Rotation: L
 Fuel feed hole: M26×1.5
 Fuel discharge hole: M18×1.5
 Cross Ref.: 42521697,
 7673 955 311,
 8001 460
 Application: Iveco

SORL No.: **YBZ17S-160L**
 Drawing No.: **3407 1707 001**
 Repair Kit.: **3407 1707 900**



Displacement: 21ml/r
 Controlled flow: 17L/min
 Max. pressure: 15MPa(Without)
 Speed range: 500-3600r/min
 Rotation: L
 Fuel feed hole: M26×1.5
 Fuel discharge hole: M18×1.5
 Cross Ref.: 7685 955 125
 8001 516, 99 444 525
 Application: Iveco EuroCargo/
 Eurostar/Eurostar cursor/Eurotech
 MH/Euro Trakker/Stralis

SORL No.: **YBZ20D1A-170L**
 Drawing No.: **3407 2181 001**
 Repair Kit.: **3407 2181 900**



Displacement: 17ml/r
 Controlled flow: 16L/min
 Max. pressure: 15MPa(Without)
 Speed range: 500-3600r/min
 Rotation: L
 Fuel feed hole: M30×2
 Fuel discharge hole: M18×1.5

Drawing No.: **3407 1729 001**
 Repair Kit.: **3407 1729 900**

Cross Ref.: 7673 955 201,
 2278075
 Application: Iveco



Displacement: 21ml/r
 Controlled flow: 20L/min
 Max. pressure: 15MPa(Without)
 Speed range: 500-3600r/min
 Rotation: R
 Fuel feed hole: M26×1.5
 Fuel discharge hole: M18×1.5
 Cross Ref.: 8695 955 116,
 8001 113, 4121 1223
 Application: Iveco Eurostar
 Iveco Eurotech MP
 Iveco Eurotech MH
 Iveco Eurotrakker
 Iveco Stralis

Drawing No.: **3407 2185 001**
 Repair Kit.: **3407 2185 900**



Displacement: 17ml/r
 Controlled flow: 16L/min
 Max. pressure: 15MPa(Without)
 Speed range: 500-3600r/min
 Rotation: L
 Fuel feed hole: M26×1.5
 Fuel discharge hole: M18×1.5

Drawing No.: **3407 1778 001**
 Repair Kit.: **3407 1778 900**

Application: Iveco



Displacement: 17.4ml/r
 Controlled flow: 16L/min
 Max. pressure: 0MPa
 Speed range: 500-3600r/min
 Rotation: L
 Fuel feed hole: M26×1.5
 Fuel discharge hole: M18×1.5
 Cross Ref.: CP287.0092.204
 Application: EUROSTAR 4*2 93-02,
 EUROTECH MP 6*4 92-
 EUROTRAKKER 4*4 93-04”

SORL No.: **3407 17214 001**



SORL No.: **3407 21258 001**

Displacement: 21ml/r
 Controlled flow: 17L/min
 Max.pressure: 0MPa
 Speed range: 500~3600r/min
 Rotation: L
 Fuel feed hole: Φ23
 Fuel discharge hole: M18×1.5
 Cross Ref:CP287.1974.210,7685 900
 103,8001 873,K S00 000 400
 Application: EuroCargo I - III
 1991-2015,EuroCarg IV 2015-
 EuroFire 1991



SORL No.: **YBZ08B-080/075**
 Drawing No.: **3407 0803 001**
 Repair Kit: **3407 0803 900**

Displacement: 8ml/r
 Controlled flow: 8L/min
 Max. pressure: 7.5MPa
 Speed range: 500-7000r/min
 Rotation: R
 Fuel feed hole: Φ16
 Fuel discharge hole: M16×1.5
 Cross Ref.: 7691 974 145,
 QVB 1011 10
 Application: 95-98 Land Rover
 Discovery



SORL No.: **3407 2539 001**

Displacement: 25ml/r
 Controlled flow: 25L/min
 Max.pressure: 0MPa
 Speed range: 500~3600r/min
 Rotation: R
 Fuel feed hole: M26×1.5
 Fuel discharge hole: M16×1.5

Cross Ref: CP240.1936.405
 Application: IVECO,RENAULT



Drawing No.: **3407 0932 001**
 Repair Kit: **3407 0932 900**

Displacement: 8.8ml/r
 Controlled flow: 8.5L/min
 Max. pressure: 10MPa
 Speed range: 500-7000r/min
 Rotation: R
 Fuel feed hole: Φ16
 Fuel discharge hole: M16×1.5
 Cross Ref.: QVB50080,
 ERR6447, QVB500080
 Application: 00-04 Land Rover
 Discovery



SORL No.: **3407 2554 001**

Displacement: 25ml/r
 Controlled flow: 18L/min
 Max.pressure: 0MPa
 Speed range: 500~3600r/min
 Rotation: R
 Fuel feed hole: M26×1.5
 Fuel discharge hole: M16×1.5

Cross Ref: 5010 557 101,542 0443 10,
 5010 383 033,2107542
 Application: IVECO,RENAULT



SORL No.: **3407 21142 001**

Displacement: 21ml/r
 Controlled flow: 18L/min
 Max.pressure: 0MPa
 Speed range: 500~3600r/min
 Rotation: L
 Fuel feed hole: M26×1.5
 Fuel discharge hole: M18×1.5

Cross Ref: 8695 955 116,8001
 113,41211223,CP289.4687.201
 Application: IVECO



SORL No.: **3407 21232 001**

Displacement: 21ml/r
 Controlled flow: 18.5L/min
 Max.pressure: 15MPa
 Speed range: 500~3600r/min
 Rotation: R
 Fuel feed hole: M26×1.5
 Fuel discharge hole: M18×1.5

Cross Ref: CP375.5714.051
 Application: MAN LION S STAR
 4*2 03.91



SORL No.: **3407 2815 001**

Displacement: 29.3ml/r
 Controlled flow: 26.5L/min
 Max.pressure: 17MPa
 Speed range: 500~3600r/min
 Rotation: L
 Fuel feed hole: M26×1.5
 Fuel discharge hole: M18×1.5
 Cross Ref: CP173.9283.012

Application: MAN:TGA TRUCK 2000-
 TGS 2007-,TGX 2007-



SORL No.: **3407 21196 001**

Displacement: 21ml/r
Controlled flow: 18L/min
Max. pressure: 0MPa
Speed range: 500~3600r/min
Rotation: R
Fuel feed hole: M26×1.5
Fuel discharge hole: M18×1.5

Cross Ref: CP196.8695.002
Application: MAN



SORL No.: **YBZ20D1A-160/100**
Drawing No.: **3407 2117 001**
Repair Kit.: **3407 2117 900**

Displacement: 21ml/r
Controlled flow: 16L/min
Max. pressure: 10MPa
Speed range: 500-3600r/min
Rotation: R
Fuel feed hole: M26×1.5
Fuel discharge hole: M18×1.5

Cross Ref.: 7685 955 131
Application: MAN



SORL No.: **YBZ16D4-160/150**
Drawing No.: **3407 1752 001**
Repair Kit.: **3407 1752 900**

Displacement: 17ml/r
Controlled flow: 16L/min
Max. pressure: 15MPa
Speed range: 500-3600r/min
Rotation: R
Fuel feed hole: M26×1.5
Fuel discharge hole: M16×1.5

Application: MAN



SORL No.: **YBZ20D1A-160/125**
Drawing No.: **3407 2118 001**
Repair Kit.: **3407 2118 900**

Displacement: 21ml/r
Controlled flow: 16L/min
Max. pressure: 12.5MPa
Speed range: 500-3600r/min
Rotation: R
Fuel feed hole: M26×1.5
Fuel discharge hole: M18×1.5

Cross Ref.: 7685 955 128
Application: MAN



SORL No.: **YBZ20D-160**
Drawing No.: **3407 2114 001**
Repair Kit.: **3407 2114 900**

Displacement: 20ml/r
Controlled flow: 16L/min
Max. pressure: 15MPa(Without)
Speed range: 500-3600r/min
Rotation: R
Fuel feed hole: M26×1.5
Fuel discharge hole: M16×1.5

Cross Ref.: 7674 955 519,
81.47101.6031
Application: MAN



SORL No.: **YBZ20D1A-160/150**
Drawing No.: **3407 2119 001**
Repair Kit.: **3407 2119 900**

Displacement: 21ml/r
Controlled flow: 16L/min
Max. pressure: 15MPa
Speed range: 500-3600r/min
Rotation: R
Fuel feed hole: M26×1.5
Fuel discharge hole: M18×1.5

Cross Ref.: 7685 955 184,
81.47101.6182
Application: MAN



SORL No.: **YBZ20D1-160**
Drawing No.: **3407 2115 001**
Repair Kit.: **3407 2115 900**

Displacement: 21ml/r
Controlled flow: 16L/min
Max. pressure: 15MPa(Without)
Speed range: 500-3200r/min
Rotation: R
Fuel feed hole: M26×1.5
Fuel discharge hole: M16×1.5

Cross Ref.: 7685 955 104
Application: MAN



SORL No.: **YBZ20D1A-190/070**
Drawing No.: **3407 2120 001**
Repair Kit.: **3407 2120 900**

Displacement: 21ml/r
Controlled flow: 19L/min
Max. pressure: 7MPa
Speed range: 500-3600r/min
Rotation: R
Fuel feed hole: M26×1.5
Fuel discharge hole: M18×1.5

Cross Ref.: 7685 955 130
Application: MAN



SORL No.: **YBZ20D1A-160/080**
Drawing No.: **3407 2116 001**
Repair Kit.: **3407 2116 900**

Displacement: 21ml/r
Controlled flow: 16L/min
Max. pressure: 8MPa
Speed range: 500-3600r/min
Rotation: R
Fuel feed hole: M26×1.5
Fuel discharge hole: M18×1.5

Cross Ref.: 7685 955 127
Application: MAN



SORL No.: **YBZ20D1A-190/120**
Drawing No.: **3407 2121 001**
Repair Kit.: **3407 2121 900**

Displacement: 21ml/r
Controlled flow: 19L/min
Max. pressure: 12MPa
Speed range: 500-3600r/min
Rotation: R
Fuel feed hole: M26×1.5
Fuel discharge hole: M18×1.5

Cross Ref.: 7685 955 129
Application: MAN



Displacement: 21ml/r
 Controlled flow: 16L/min
 Max. pressure: 15MPa(Without)
 Speed range: 500-3600r/min
 Rotation: R
 Fuel feed hole: M26×1.5
 Fuel discharge hole: M16×1.5
 Cross Ref.: 81.47101.6189,
 81.47101.9189, 7685 955 152,
 8001 489
 Application: MAN
 SORL No.: **YBZ20D2-160**
 Drawing No.: **3407 2123 001**
 Repair Kit.: **3407 2123 900**



Displacement: 20ml/r
 Controlled flow: 16L/min
 Max. pressure: 15MPa(Without)
 Speed range: 500-3600r/min
 Rotation: R
 Fuel feed hole: M26×1.5
 Fuel discharge hole: M18×1.5
 Cross Ref.: 81.47101.6031,
 7674 955 519
 Application: MAN
 SORL No.: **YBZ20D-160**
 Drawing No.: **3407 2149 001**
 Repair Kit.: **3407 2149 900**



Displacement: 21ml/r
 Controlled flow: 18L/min
 Max. pressure: 15MPa(Without)
 Speed range: 500-3600r/min
 Rotation: L
 Fuel feed hole: M26×1.5
 Fuel discharge hole: M18×1.5
 Cross Ref.: 7685 955 153,
 81.47101.6190
 Application: MAN
 SORL No.: **YBZ20D2A-180L**
 Drawing No.: **3407 2124 001**
 Repair Kit.: **3407 2124 900**



Displacement: 21ml/r
 Controlled flow: 14L/min
 Max. pressure: 15MPa
 Speed range: 500-3600r/min
 Rotation: L
 Fuel feed hole: M26×1.5
 Fuel discharge hole: M16×1.5
 Application: MAN
 SORL No.: **YBZ20D2A-140/150L**
 Drawing No.: **3407 2158 001**
 Repair Kit.: **3407 2158 900**



Displacement: 21ml/r
 Controlled flow: 16L/min
 Max. pressure: 15MPa(Without)
 Speed range: 500-3600r/min
 Rotation: R
 Fuel feed hole: M26×1.5
 Fuel discharge hole: M18×1.5
 Cross Ref.: 81.47101.6122,
 81.47101.6137,81.47101.6162,
 81.47101.6181,81.47101.9137,
 81.47101.9162,542 0023 10,
 542 0059 10,542 0066 10
 Application: MAN
 SORL No.: **YBZ20D3-160**
 Drawing No.: **3407 2125 001**
 Repair Kit.: **3407 2125 900**



Displacement: 21ml/r
 Controlled flow: 16L/min
 Max. pressure: 15MPa
 Speed range: 500-3200r/min
 Rotation: R
 Fuel feed hole: M26×1.5
 Fuel discharge hole: M16×1.5
 Cross Ref.: 81.47101.6137,
 8225000136, 7685 955 102
 Application: MAN
 SORL No.: **YBZ20D1-160/150**
 Drawing No.: **3407 2164 001**
 Repair Kit.: **3407 2164 900**



Displacement: 21ml/r
 Controlled flow: 16L/min
 Max. pressure: 15MPa(Without)
 Speed range: 500-3600r/min
 Rotation: R
 Fuel feed hole: M26×1.5
 Fuel discharge hole: M16×1.5
 Cross Ref.: 81.47101.6122,
 81.47101.6162 542 0023 10
 Application: MAN
 SORL No.: **YBZ20D3A-160**
 Drawing No.: **3407 2126 001**
 Repair Kit.: **3407 2126 900**



Displacement: 21ml/r
 Controlled flow: 17L/min
 Max. pressure: 15MPa(Without)
 Speed range: 500-3600r/min
 Rotation: L
 Fuel feed hole: M26×1.5
 Fuel discharge hole: M18×1.5
 Application: MAN
 SORL No.: **YBZ20D3-170L**
 Drawing No.: **3407 2182 001**
 Repair Kit.: **3407 2182 900**



Displacement: 21ml/r
 Controlled flow: 16L/min
 Max. pressure: 13MPa
 Speed range: 500-3500r/min
 Rotation: L
 Fuel feed hole: M26×1.5
 Fuel discharge hole: M18×1.5
 Application: MAN
 SORL No.: **YBZ20D2A-160/130L**
 Drawing No.: **3407 2128 001**
 Repair Kit.: **3407 2128 900**

Cross Ref.: 81.47101.6086,
 81.47101.6090
 81.47101.6103, 81.47101.6116
 81.47101.6121, 81.47101.6140
 81.47101.6161, 81.47101.6168
 81.47101.6170, 81.47101.6180
 81.47101.9121, 81.47101.9161
 542 0022 10, 542 0464 10
 TT21.01.021, 12-34 631 0001
 Application: MAN

Pictures And/Or OEM Part Numbers are for reference purpose only.



SORL No.: **YBZ20D1A-170L**
 Drawing No.: **3407 2181 001**
 Repair Kit.: **3407 2181 900**

Displacement: 21ml/r
 Controlled flow: 17L/min
 Max. pressure: 15MPa(Without)
 Speed range: 500-3600r/min
 Rotation: L
 Fuel feed hole: M26×1.5
 Fuel discharge hole: M18×1.5
 Cross Ref.: 81.47101.6136,
 81.47101.6161,81.47101.9136,
 7685 955 125, 8001 516
 Application: MAN EM/F90/F2000/
 E2000/L2000/M2000L
 SONDERFAHRZEUGE TGA TGS TGX



SORL No.: **YBZ11P4-080/120**
 Drawing No.: **3407 1115 001**
 Repair Kit.: **3407 1115 900**

Displacement: 11ml/r
 Controlled flow: 8.5L/min
 Max. pressure: 12MPa
 Speed range: 500-7000r/min
 Rotation: R
 Fuel feed hole: Φ16
 Fuel discharge hole: M16×1.5
 Cross Ref.: 002 466 4901,
 2107370
 Application: Mercedes

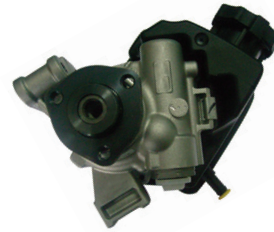

Drawing No.: **3407 1128 001**
 Repair Kit.: **3407 1128 900**

Displacement: 11ml/r
 Controlled flow: 8L/min
 Max. pressure: 11MPa
 Speed range: 500-7000r/min
 Rotation: R
 Fuel feed hole: Φ10
 Fuel discharge hole: M16×1.5
 Cross Ref.: A002 466 7601,
 7692 900 510
 Application: Mercedes Sprinter 315D
 Sprinter 415D, Sprinter T1N



Drawing No.: **3407 08106 001**
 Repair Kit.:

Displacement: 11ml/r
 Controlled flow: 8L/min
 Max. pressure: 10MPa
 Speed range: 400-7000r/min
 Rotation: L
 Fuel feed hole: Φ17.5
 Fuel discharge hole: M16×1.5

Cross Ref: ZF 7691 955 910
 Application: For Benz



Drawing No.: **3407 1151 001**
 Repair Kit.: **3407 1151 900**

Displacement: 11ml/r
 Controlled flow: 8.5L/min
 Max. pressure: 10MPa
 Speed range: 500-8000r/min
 Rotation: R
 Fuel feed hole: Φ16
 Fuel discharge hole: M16×1.5
 Cross Ref.: 003 466 6401,
 003 466 0080, 8001 615
 Application: 03-05 Mercedes ML350
 04-05 Mercedes ML500



Drawing No.: **3407 08111 001**
 Repair Kit.:

Displacement: 11ml/r
 Controlled flow: 9L/min
 Max. pressure: 10MPa
 Speed range: 400-7000r/min
 Rotation: L
 Fuel feed hole: Φ17.5
 Fuel discharge hole: M16×1.5

Cross Ref: ZF 7691 955 921
 Application: For Benz



SORL No.: **YBZ17D-160/130**
 Drawing No.: **3407 1701 001**
 Repair Kit.: **3407 1701 900**

Displacement: 17ml/r
 Controlled flow: 16L/min
 Max. pressure: 13MPa
 Speed range: 500-3600r/min
 Rotation: R
 Fuel feed hole: M26×1.5
 Fuel discharge hole: M16×1.5

Cross Ref.: 7673 955 572
 Application: Mercedes



SORL No.: **YBZ11P1-080/115**
 Drawing No.: **3407 11302 001**
 Repair Kit.: **3407 11302 900**

Displacement: 11ml/r
 Controlled flow: 8L/min
 Max. pressure: 11.5MPa
 Speed range: 500-7000r/min
 Rotation: R
 Fuel feed hole: Φ10
 Fuel discharge hole: M16×1.5
 Cross Ref.: 002 466 2601,
 002 466 2801, 003 466 0701,
 2106 468, 542 0035 10, 2761 901
 Application: Mercedes



Drawing No.: **3407 1703 001**
 Repair Kit.: **3407 1703 900**

Displacement: 17ml/r
 Controlled flow: 16L/min
 Max. pressure: 10MPa
 Speed range: 500-3600r/min
 Rotation: R
 Fuel feed hole: M26×1.5
 Fuel discharge hole: M16×1.5

Cross Ref.: 7673 955 573
 Application: Mercedes



Displacement: 17ml/r
Controlled flow: 16L/min
Max. pressure: 10MPa
Speed range: 500-3600r/min
Rotation: R
Fuel feed hole: M26×1.5
Fuel discharge hole: M16×1.5

Drawing No.: **3407 1704 001**
Repair Kit.: **3407 1704 900**

Cross Ref.: 7673 955 908,
345 466 0001
Application: Mercedes



Displacement: 17.5ml/r
Controlled flow: 20L/min
Max. pressure: 0MPa
Speed range: 500-3600r/min
Rotation: R
Fuel feed hole: M26×1.5
Fuel discharge hole: M18×1.5

Drawing No.: **3407 17143 001**
Repair Kit.:

Cross Ref: LUK 542 0048 10
001 460 3180
001 460 5280A
Application: Mercedes Benz ACTROS



Displacement: 17ml/r
Controlled flow: 16L/min
Max. pressure: 13MPa
Speed range: 500-3600r/min
Rotation: L
Fuel feed hole: M26×1.5
Fuel discharge hole: M16×1.5

Drawing No.: **3407 1706 001**
Repair Kit.: **3407 1706 900**

Cross Ref.: 7673 955 550
Application: Mercedes



Displacement: 17ml/r
Controlled flow: 16L/min
Max. pressure: 15MPa(Without)
Speed range: 500-3600r/min
Rotation: L
Fuel feed hole: M26×1.5
Fuel discharge hole: M16×1.5

Drawing No.: **3407 1726 001**
Repair Kit.: **3407 1726 900**

Cross Ref.: 7673 955 366,
8001 502, 002 460 4280
Application: Mercedes



Displacement: 16ml/r
Controlled flow: 16L/min
Max. pressure: 10MPa
Speed range: 500-3600r/min
Rotation: R
Fuel feed hole: M30×2
Fuel discharge hole: M18×1.5
Cross Ref.: 7673 955 116,
8001 450, 000 466 7601,
000 460 6701
Application: Mercedes

SORL No.: **YBZ16D3-160/100**
Drawing No.: **3407 1708 001**
Repair Kit.: **3407 1708 900**



Displacement: 17ml/r
Controlled flow: 16L/min
Max. pressure: 15MPa(Without)
Speed range: 500-3600r/min
Rotation: R
Fuel feed hole: M26×1.5
Fuel discharge hole: M16×1.5

Drawing No.: **3407 1742 001**
Repair Kit.: **3407 1742 900**

Application: Mercedes



Displacement: 16ml/r
Controlled flow: 16L/min
Max. pressure: 12MPa
Speed range: 500-3600r/min
Rotation: R
Fuel feed hole: M26×1.5
Fuel discharge hole: M16×1.5

SORL No.: **YBZ16D3-160/120**
Drawing No.: **3407 1709 001**
Repair Kit.: **3407 1709 900**

Cross Ref.: 7673 955 534,
001 466 1301
Application: Mercedes



Displacement: 17ml/r
Controlled flow: 17L/min
Max. pressure: 9MPa
Speed range: 500-3600r/min
Rotation: R
Fuel feed hole: M26×1.5
Fuel discharge hole: M16×1.5

Drawing No.: **3407 1768 001**
Repair Kit.: **3407 1768 900**

Cross Ref.: 001 466 4501,
001 460 5980,
001 466 4401,
000 460 6780,
000 460 1580,
000 460 2580,
002 460 7580,
7684 955 190,
0346310001,
2836 801,
2837 001
Application: Mercedes



Displacement: 16ml/r
Controlled flow: 16L/min
Max. pressure: 10MPa
Speed range: 500-3600r/min
Rotation: R
Fuel feed hole: M26×1.5
Fuel discharge hole: M16×1.5
Cross Ref.: 7684 955 198,
001 460 1480, 001 460 6080,
002 466 5701, 001 466 4301
Application: Mercedes

SORL No.: **YBZ16D4-160/100**
Drawing No.: **3407 1713 001**
Repair Kit.: **3407 1713 900**

Pictures And/Or OEM Part Numbers are for reference purpose only.



SORL No.: **YBZ16D4-160/150**
 Drawing No.: **3407 1752 001**
 Repair Kit.: **3407 1752 900**

Displacement: 17.5ml/r
 Controlled flow: 16L/min
 Max. pressure: 15MPa
 Speed range: 500-3600r/min
 Rotation: R
 Fuel feed hole: M26×1.5
 Fuel discharge hole: M16×1.5

Application: Mercedes



Drawing No.: **3407 1769 001**
 Repair Kit.: **3407 1769 900**

Displacement: 16ml/r
 Controlled flow: 15L/min
 Max. pressure: 9MPa
 Speed range: 500-3600r/min
 Rotation: R
 Fuel feed hole: Φ19
 Fuel discharge hole: 3/4-16UNF
 Cross Ref.: 7684 955 921
 Application: Mercedes
 712C,914C,915LTC,LO914C,
 LO915,1215C



Drawing No.: **3407 1771 001**
 Repair Kit.: **3407 1771 900**

Displacement: 17ml/r
 Controlled flow: 12L/min
 Max. pressure: 10MPa
 Speed range: 500-3600r/min
 Rotation: R
 Fuel feed hole: M30×2
 Fuel discharge hole: M18×1.5

Cross Ref.: 7673 955 127,
 001 466 7101

Application: Mercedes
 HPN 1214/1218,
 HPN 1414/1418,
 HPN 1614/1618,
 HPN 2314/2318,
 L 1218(Model O96),
 LK 1218(Model O96),
 1418(Model O96),
 1420



Drawing No.: **3407 1774 001**
 Repair Kit.: **3407 1774 900**

Displacement: 17ml/r
 Controlled flow: 13L/min
 Max. pressure: 10MPa
 Speed range: 500-3600r/min
 Rotation: R
 Fuel feed hole: M26×1.5
 Fuel discharge hole: M16×1.5
 Cross Ref.: 000 466 7001,
 001 466 2301, 001 466 2701,
 001 466 2801, 7673 955 554,
 542 0036 10, 8001 465
 Application: Mercedes O371/
 OF1115(1315)/OF1318(1319)/
 OH1318/OH1319

Drawing No.: **3407 1776 001**
 Repair Kit.: **3407 1776 900**

Displacement: 17ml/r
 Controlled flow: 10L/min
 Max. pressure: 10MPa
 Speed range: 500-3600r/min
 Rotation: R
 Fuel feed hole: M26×1.5
 Fuel discharge hole: M16×1.5

Cross Ref.: 7673 955 913
 Application: Mercedes



Drawing No.: **3407 1775 001**
 Repair Kit.: **3407 1775 900**

Displacement: 17ml/r
 Controlled flow: 12L/min
 Max. pressure: 10MPa
 Speed range: 500-3600r/min
 Rotation: R
 Fuel feed hole: M26×1.5
 Fuel discharge hole: M16×1.5

Cross Ref.: 001 466 3501,
 7673 955 125,8001 466

Application:
 Mercedes 1113/1213/1313
 1513/2013/2213
 L 1214/1218/1414
 L 1418/1614/1618
 L 1621/2314/2318
 LK 1214/1218/1414
 LK 1614/1618/1621
 LK 2314/2318
 O362/O364/O365



Drawing No.: **3407 17158 001**
 Repair Kit.: **3407 17158 900**

Displacement: 17ml/r
 Controlled flow: 17L/min
 Max. pressure: 12MPa
 Speed range: 500-3600r/min
 Rotation: L
 Fuel feed hole: M26×1.5
 Fuel discharge hole: M16×1.5

Cross Ref.: 001 460 8480,
 7684 955 913

Application:
 Mercedes Atego 2423B/2423K/
 2428/1315/1418/1718/
 1725/2423/2425L1418/
 O-500/OF1318/1417/
 1722/OH1418/1618L-SB



Displacement: 17ml/r
Controlled flow: 15L/min
Max. pressure: 7MPa
Speed range: 500-3600r/min
Rotation: R
Fuel feed hole: M26×1.5
Fuel discharge hole: M16×1.5

Cross Ref.: 7673 955 933,
7673 955 862, 811857
Application: HYSTER
H35/H45/H55N

Drawing No.: **3407 1777 001**
Repair Kit.: **3407 1777 900**



Displacement: 17ml/r
Controlled flow: 17L/min
Max. pressure: 15MPa(Without)
Speed range: 500-3600r/min
Rotation: L
Fuel feed hole: M26×1.5
Fuel discharge hole: M16×1.5
Cross Ref No.: 7684 955 121,
002 460 1380,489 1342,
8001 868
Application: Mercedes

Drawing No.: **3407 1782 001**
Repair Kit.: **3407 1782 900**



Displacement: 17ml/r
Controlled flow: 17L/min
Max. pressure: 10MPa
Speed range: 500-3600r/min
Rotation: R
Fuel feed hole: M26×1.5
Fuel discharge hole: M16×1.5
Cross Ref.: 001 466 1801,
002 460 7680,
001 460 6080,
542 0032 10
Application: Mercedes

Drawing No.: **3407 1779 001**
Repair Kit.: **3407 1779 900**



Displacement: 21ml/r
Controlled flow: 19L/min
Max. pressure: 15MPa
Speed range: 500-3600r/min
Rotation: L
Fuel feed hole: M26×1.5
Fuel discharge hole: M18×1.5
Cross Ref.: 002 460 3580,
002 460 5280,7685 955 249,
8001 879
Application: Mercedes

SORL No.: **YBZ20D2A-190/150L**
Drawing No.: **3407 2137 001**
Repair Kit.: **3407 2137 900**



Displacement: 17ml/r
Controlled flow: 16L/min
Max. pressure: 15MPa(Without)
Speed range: 500-3600r/min
Rotation: R
Fuel feed hole: M26×1.5
Fuel discharge hole: M16×1.5

Cross Ref.: 7684 955 903
OH 1628L/0400UPA
Application: Mercedes

Drawing No.: **3407 1781 001**
Repair Kit.: **3407 1781 900**



Displacement: 21ml/r
Controlled flow: 20L/min
Max. pressure: 15MPa(Without)
Speed range: 500-3500r/min
Rotation: R
Fuel feed hole: M26×1.5
Fuel discharge hole: M16×1.5

Cross Ref.: 8695 955 147,
A0034601980
Application: Mercedes

Drawing No.: **3407 2139 001**
Repair Kit.: **3407 2139 900**



Displacement: 21ml/r
Controlled flow: 20L/min
Max. pressure: 15MPa
Speed range: 500-3500r/min
Rotation: R
Fuel feed hole: M26×1.5
Fuel discharge hole: M16×1.5

SORL No.: **YBZ21D-200**
Drawing No.: **3407 2104 001**
Repair Kit.: **3407 2104 900**

Cross Ref.: 8695 955 107,
8695 955 113, 8695 955 147,
8001 901,542 0047 10,
002 460 3980,003 460 1980
Application:
Mercedes Actros 1831-1860
Actros 2031-2055
Actros 2432-2448
Actros 2531-2560



Displacement: 21ml/r
Controlled flow: 19L/min
Max. pressure: 15MPa(Without)
Speed range: 500-3600r/min
Rotation: L
Fuel feed hole: M26×1.5
Fuel discharge hole: M16×1.5
Cross Ref.: 002 460 1580,
002 460 1780, 002 460 4980,
457 460 0280, 7685 955 247,
542 0092 10
Application: Mercedes Axor

SORL No.: **YBZ20D3A-190L**
Drawing No.: **3407 2143 001**
Repair Kit.: **3407 2143 900**



Displacement: 21ml/r
Controlled flow: 19L/min
Max. pressure: 15MPa(Without)
Speed range: 500-3600r/min
Rotation: R
Fuel feed hole: M26×1.5
Fuel discharge hole: M16×1.5

SORL No.: **YBZ20D3A-190**
Drawing No.: **3407 2157 001**
Repair Kit.: **3407 2157 900**

Application: Mercedes



Drawing No.: **3407 2175 001**
Repair Kit.: **3407 2175 900**

Displacement: 21ml/r
Controlled flow: 20L/min
Max. pressure: 15MPa(Without)
Speed range: 500-3500r/min
Rotation: R
Fuel feed hole: M26×1.5
Fuel discharge hole: M18×1.5
Cross Ref.: 002 460 8880,
002 460 8980, 003 460 4980,
542 0453 10
Application: Mercedes Actros, Axor



SORL No.: **YBZ20D1-180/130**
Drawing No.: **3407 21105 001**
Repair Kit.: **3407 21105 900**

Displacement: 21ml/r
Controlled flow: 18L/min
Max. pressure: 13MPa
Speed range: 500-3600r/min
Rotation: R
Fuel feed hole: M26×1.5
Fuel discharge hole: M16×1.5
Cross Ref.: 7685 955 145, 7685
955 264,8001 875, 002 460 6680
Application: Mercedes Atego, Axor
O405/O407/O408



Drawing No.: **3407 2177 001**
Repair Kit.: **3407 2177 900**

Displacement: 21ml/r
Controlled flow: 16L/min
Max. pressure: 15MPa
Speed range: 500-3600r/min
Rotation: L
Fuel feed hole: M26×1.5
Fuel discharge hole: M16×1.5

Cross Ref.: 002 460 1580,
002 460 4980
Application: Mercedes



Drawing No.: **3407 2510 001**
Repair Kit.:

Displacement: 25ml/r
Controlled flow: 17L/min
Max. pressure: 0MPa
Speed range: 500-3600r/min
Rotation: R
Fuel feed hole: M26×1.5
Fuel discharge hole: M18×1.5

Cross Ref: LUK 542 0047 10
DT4.61747 001 460 3080
002 460 0880 002 460 3980
Application: Mercedes Benz ACTROS



SORL No.: **YBZ20D1-180/155**
Drawing No.: **3407 2178 001**
Repair Kit.: **3407 2178 900**

Displacement: 21ml/r
Controlled flow: 18L/min
Max. pressure: 15.5MPa
Speed range: 500-3600r/min
Rotation: R
Fuel feed hole: M26×1.5
Fuel discharge hole: M16×1.5
Cross Ref.: 001 460 7280,
001 460 6880, 002 460 6480,
034 631 0008
Application: Mercedes



Drawing No.: **3407 2512 001**
Repair Kit.:

Displacement: 25ml/r
Controlled flow: 20L/min
Max. pressure: 0MPa
Speed range: 500-3600r/min
Rotation: R
Fuel feed hole: M26×1.5
Fuel discharge hole: M18×1.5

Cross Ref: LUK 542 0453 10
002 460 8880
003 460 4980
Application: Mercedes Benz ACTROS



SORL No.: **YBZ20D1-180**
Drawing No.: **3407 2179 001**
Repair Kit.: **3407 2179 900**

Displacement: 21ml/r
Controlled flow: 18L/min
Max. pressure: 15MPa(Without)
Speed range: 500-3600r/min
Rotation: R
Fuel feed hole: M26×1.5
Fuel discharge hole: M16×1.5

Cross Ref.: 001 460 7080
001 460 7180, 002 460 6580
Application: Mercedes



Drawing No.: **3407 2513 001**
Repair Kit.:

Displacement: 25ml/r
Controlled flow: 25L/min
Max. pressure: 0MPa
Speed range: 500-3600r/min
Rotation: R
Fuel feed hole: M26×1.5
Fuel discharge hole: M18×1.5

Cross Ref: LUK 542 0454 10
003 460 0380 003 460 5280
003 460 5580
Application: Mercedes Benz ACTROS



SORL No.: **YBZ20D1-180L**
Drawing No.: **3407 2180 001**
Repair Kit.: **3407 2180 900**

Displacement: 21ml/r
Controlled flow: 18L/min
Max. pressure: 15MPa(Without)
Speed range: 500-3600r/min
Rotation: L
Fuel feed hole: M26×1.5
Fuel discharge hole: M16×1.5
Cross Ref.: 001 460 4480,
001 460 7580,002 460 5480,
7685 955 139,7685 955 246,
8001 491
Application: Mercedes Atego/Axor
1938S/1944S/L1632/L2638/LK2638/
LS1632/LS1634/LS1938/LS2638



Drawing No.: **3407 3413 001**
Repair Kit.:

Displacement: 34ml/r
Controlled flow: 21L/min
Max. pressure: 0MPa
Speed range: 500-3200r/min
Rotation: R
Fuel feed hole: M33×2
Fuel discharge hole: M22×1.5

Cross Ref: ZF 7677 955 201
8001 511
001 460 0580
Application: Mercedes Benz ACTROS



SORL No.: **3407 11208 001**

Displacement: 11ml/r
Controlled flow: 8L/min
Max.pressure: 12MPa
Speed range: 500~7000r/min
Rotation: R
Fuel feed hole: $\Phi 10$
Fuel discharge hole: M16 \times 1.5

Cross Ref: ER-04018
Application: MERCEDES BENZ



SORL No.: **3407 17158 001**

Displacement: 17ml/r
Controlled flow: 17L/min
Max.pressure: 0MPa
Speed range: 500~3600r/min
Rotation: L
Fuel feed hole: M26 \times 1.5
Fuel discharge hole: M16 \times 1.5
Cross Ref: 46-182,7684 955 913, 001 460 8480
Application: BENZ 2423B,2423K, 2428,ATEGO 1315,1418,1718,ATEGO



SORL No.: **3407 11302 001**

Displacement: 11ml/r
Controlled flow: 8L/min
Max.pressure: 12MPa
Speed range: 500~7000r/min
Rotation: R
Fuel feed hole: $\Phi 10$
Fuel discharge hole: M16 \times 1.5

Cross Ref: ER-03838
Application: MERCEDES BENZ



SORL No.: **3407 17168 001**

Displacement: 17.5ml/r
Controlled flow: 18L/min
Max.pressure: 0MPa
Speed range: 500~3600r/min
Rotation: R
Fuel feed hole: M26 \times 1.5
Fuel discharge hole: M16 \times 1.5

Cross Ref: CP190.4356.007
Application: BENZ



SORL No.: **3407 11306 001**

Displacement: 11ml/r
Controlled flow: 8.5L/min
Max.pressure: 12MPa
Speed range: 500~7000r/min
Rotation: R
Fuel feed hole: $\Phi 10$
Fuel discharge hole: M16 \times 1.5

Cross Ref: CP074.3853.764
Application: MERCEDES BENZ



SORL No.: **3407 21193 001**

Displacement: 21ml/r
Controlled flow: 18L/min
Max.pressure: 0MPa
Speed range: 500~3600r/min
Rotation: R
Fuel feed hole: M26 \times 1.5
Fuel discharge hole: M16 \times 1.5

Cross Ref: CP087.2225.611
Application: BENZ



SORL No.: **3407 11337 001**

Displacement: 11ml/r
Controlled flow: 10L/min
Max.pressure: 12MPa
Speed range: 500~7000r/min
Rotation: R
Fuel feed hole: $\Phi 10$
Fuel discharge hole: M16 \times 1.5
Cross Ref: CP376.1230.769, 006 466 7801,006 466 1701,
Application: SPRINTER 2500, 3500 2.1l diesel Turbocharged 2014



SORL No.: **3407 2537 001**

Displacement: 25ml/r
Controlled flow: 25L/min
Max.pressure: 12MPa
Speed range: 500~3600r/min
Rotation: R
Fuel feed hole: M26 \times 1.5
Fuel discharge hole: M18 \times 1.5

Cross Ref: 7685 955 134, 001 460 2880
Application: BENZ



SORL No.: **3407 1353 001**

Displacement: 13ml/r
Controlled flow: 12L/min
Max.pressure: 13MPa
Speed range: 500~3600r/min
Rotation: L
Fuel feed hole: $\Phi 22$
Fuel discharge hole: M16 \times 1.5

Cross Ref: A400 460 0080
Application: BHARAT BENZ



SORL No.: **3407 2809 001**

MERCEDES
Displacement: 27.9ml/r
Controlled flow: 23L/min
Max.pressure: 0MPa
Speed range: 500~3600r/min
Rotation: L
Fuel feed hole: M26 \times 1.5
Fuel discharge hole: M18 \times 1.5
Cross Ref: 003 460 5480,003 460 0280,CP265.1643.712
Application: BENZ



SORL No.: **3407 17167 001**

Displacement: 16.6ml/r
 Controlled flow: 13L/min
 Max.pressure: 10MPa
 Speed range: 500~3600r/min
 Rotation: R
 Fuel feed hole: M26×1.5
 Fuel discharge hole: M16×1.5

Cross Ref: CP248.6617.754
 Application: BENZ O371,OF1115
 OF1318(1319),OH1318,OH1319



SORL No.: **3407 2523 001**

Displacement: 21ml/r
 Controlled flow: 19L/min
 Max.pressure: 0MPa
 Speed range: 500~3600r/min
 Rotation: R
 Fuel feed hole: M26×1.5
 Fuel discharge hole: M18×1.5

Cross Ref: CP1991035
 Application: Mercedes Benz ACTROS



SORL No.: **3407 2820 001**

Displacement: 21ml/r
 Controlled flow: 20L/min
 Max.pressure: 0MPa
 Speed range: 500~3600r/min
 Rotation: R
 Fuel feed hole: M26×1.5
 Fuel discharge hole: M18×1.5

Cross Ref: CP266.1823.450 003 460 2380
 Application: BENZ ACTROS MP2,MP3
 2002-,TRAVEGO(O 580)1999-



SORL No.: **3407 2705 001**

Displacement: 27.2ml/r
 Controlled flow: 23L/min
 Max.pressure: 0MPa
 Speed range: 500~3600r/min
 Rotation: R
 Fuel feed hole: M26×1.5
 Fuel discharge hole: M18×1.5

Cross Ref: CP189.1129.432
 Application: Mercedes Benz ACTROS



SORL No.: **3407 21206 001**

Displacement: 21ml/r
 Controlled flow: 19L/min
 Max.pressure: 0MPa
 Speed range: 500~3600r/min
 Rotation: L
 Fuel feed hole: M26×1.5
 Fuel discharge hole: M16×1.5

Cross Ref: CP074.1729.441
 Application:



SORL No.: **3407 17224 001**

Displacement: 17.5ml/r
 Controlled flow: 20L/min
 Max.pressure: 0MPa
 Speed range: 500~3600r/min
 Rotation: R
 Fuel feed hole: M26×1.5
 Fuel discharge hole: M16×1.5

Cross Ref: 542 0047 10,001 460 3080,
 002 460 0880,002 460 3980
 Application: Mercedes Benz ACTROS



SORL No.: **3407 21210 001**

Displacement: 21ml/r
 Controlled flow: 20L/min
 Max.pressure: 0MPa
 Speed range: 500~3600r/min
 Rotation: R
 Fuel feed hole: M26×1.5
 Fuel discharge hole: M16×1.5

Cross Ref: CP074.1735.747
 Application: Mercedes Benz ACTROS



SORL No.: **3407 2816 001**

Displacement: 29.3ml/r
 Controlled flow: 24L/min
 Max.pressure: 18.5MPa
 Speed range: 500~3600r/min
 Rotation: L
 Fuel feed hole: M26×1.5
 Fuel discharge hole: M18×1.5

Cross Ref: CP074.1732.442
 Application: BENZ ATEGO 98-04, AREGO2
 04-, AXOR 01-05, AXOR2 04-, ECONIC98-
 ,INTEGRO(O 550)96-,INTOURO 05-, O 403
 95-06,TOURISMO(O 350)94-, TRAVEGO(O
 580)99-



SORL No.: **3407 2409 001**

Displacement: 23.6ml/r
 Controlled flow: 24L/min
 Max.pressure: 0MPa
 Speed range: 500~3600r/min
 Rotation: R
 Fuel feed hole: M26×1.5
 Fuel discharge hole: M18×1.5

Cross Ref: CP:074.1695.162
 Application: Mercedes Benz ACTROS



SCANIA



Displacement: 17.5ml/r
Controlled flow: 15L/min
Max. pressure: 15MPa
Speed range: 500-3600r/min
Rotation: R
Fuel feed hole: 1-5/16-12UN
Fuel discharge hole: 3/4-16UNF

SORL No.: **YBZ18C-150/150**
Drawing No.: **3407 1806 900**
Repair Kit.: **3407 1806 900**

Cross Ref.: LF732/107546
542 0130 10, TT21.01.035
Application: Scania



Displacement: 20ml/r
Controlled flow: 15L/min
Max. pressure: 13MPa
Speed range: 500-3000r/min
Rotation: L
Fuel feed hole: M26×1.5
Fuel discharge hole: M16×1.5

Drawing No.: **3407 2041 001**
Repair Kit.: **3407 2041 900**

Cross Ref.: 394443, 7674 955,
284 8001 473
Application: Scania



Displacement: 18ml/r
Controlled flow: 16L/min
Max. pressure: 15MPa(Without)
Speed range: 500-3000r/min
Rotation: R
Fuel feed hole: M26×1.5
Fuel discharge hole: M16×1.5

Drawing No.: **3407 1808 001**
Repair Kit.: **3407 1808 900**

Cross Ref.: 012.632.510,
0126.325.10,126.325.10,
1308 495,1421 272,
1457 708,571 434,
VT75/02 105277,
TT21.01.003, 1.19099
1.19107, 542 0008 10
Application: Scania



Displacement: 21ml/r
Controlled flow: 16L/min
Max. pressure: 15MPa(Without)
Speed range: 500-3600r/min
Rotation: R
Fuel feed hole: M26×1.5
Fuel discharge hole: M16×1.5
Cross Ref.: 1333 790, 1422 417
1457 710, 1571,571 436, 397,
VT75A 17K03 6862, TT21.01.006
834 631 0001, 1.19113
58.0002, 542 0013 10
Application: Scania

SORL No.: **YBZ20A-160**
Drawing No.: **3407 2109 001**
Repair Kit.: **3407 2109 900**



Displacement: 21ml/r
Controlled flow: 19L/min
Max. pressure: 15MPa(Without)
Speed range: 500-3600r/min
Rotation: R
Fuel feed hole: M26×1.5
Fuel discharge hole: M16×1.5
Cross Ref.: 1324 223, 1421 273
1457 709, 571 435 ,VT75 2105485,
TT21.01.004,1.19114, 1.19119
542 0010 10
Application: Scania

SORL No.: **YBZ20A1-190**
Drawing No.: **3407 2110 001**
Repair Kit.: **3407 2110 900**



Displacement: 17.5ml/r
Controlled flow: 16L/min
Max. pressure: 13.5MPa
Speed range: 500-3000r/min
Rotation: L
Fuel feed hole: M26×1.5
Fuel discharge hole: M16×1.5
Cross Ref.: 1082 959, 1082 959-6
3172 199, 8112 286,8112 286-3,
8113 432, VT74 2108165,
VT74 0516146,TT21.01.001,
2.53201, 542 0001 10
Application: Scania

SORL No.: **YBZ18C1-160/135**
Drawing No.: **3407 1805 001**
Repair Kit.: **3407 1805 900**



Displacement: 21ml/r
Controlled flow: 22L/min
Max. pressure: 15MPa(Without)
Speed range: 500-3600r/min
Rotation: R
Fuel feed hole: M26×1.5
Fuel discharge hole: M16×1.5
Cross Ref.: 1332 653, 1421 628
1457 711, 571 437,1.19116
VT75A 2106214, 542 0012 10,
834 631 0004,TT21.01.011
Application: Scania

SORL No.: **YBZ20A2-220**
Drawing No.: **3407 2111 001**
Repair Kit.: **3407 2111 900**



Displacement: 20ml/r
Controlled flow: 15L/min
Max. pressure: 15MPa(Without)
Speed range: 500-3000r/min
Rotation: L
Fuel feed hole: M26×1.5
Fuel discharge hole: M16×1.5

Drawing No.: **3407 2040 001**
Repair Kit.: **3407 2040 900**

Cross Ref.: 7674 955 217,
571370
Application: Scania



Displacement: 21ml/r
Controlled flow: 19L/min
Max. pressure:
15MPa(Without)
Speed range: 500-3600r/min
Rotation: L
Fuel feed hole: M26×1.5
Fuel discharge hole: M16×1.5
Cross Ref.: 1299411,
VT77 2105576
Application: Scania

Drawing No.: **3407 2129 001**
Repair Kit.: **3407 2129 900**



Drawing No.: **3407 3403 001**
Repair Kit.: **3407 3403 900**

Displacement: 34ml/r
Controlled flow: 14L/min
Max. pressure: 13MPa
Speed range: 500-3600r/min
Rotation: R
Fuel feed hole: M26×1.5
Fuel discharge hole: M16×1.5

Cross Ref.: 255 028,
571 364,
10571028,
10571364,
1571364,
571028,
58.0017
7677 955 106,
8001 478
TT21.00.019,
20183 01,
1.19100
Application: Scania



Drawing No.: **3407 3408 001**
Repair Kit.: **3407 3408 900**

Displacement: 34ml/r
Controlled flow: 15L/min
Max. pressure: 8.5MPa
Speed range: 500-3600r/min
Rotation: R
Fuel feed hole: M26×1.5
Fuel discharge hole: M16×1.5
Cross Ref.: 7677 955 110
Application: Scania BR116/L111/
LK111/LS111/LT111
RANDON RK424/RK425



Drawing No.: **3407 3411 001**
Repair Kit.: **3407 3411 900**

Displacement: 34ml/r
Controlled flow: 25L/min
Max. pressure: 13MPa
Speed range: 500-3600r/min
Rotation: L
Fuel feed hole: M26×1.5
Fuel discharge hole: M16×1.5

Cross Ref.: 300130
7677 955 129, 8001 479
Application: Scania



Drawing No.: **3407 3405 001**
Repair Kit.: **3407 3405 900**

Displacement: 34ml/r
Controlled flow: 15L/min
Max. pressure: 13MPa
Speed range: 500-3600r/min
Rotation: L
Fuel feed hole: M26×1.5
Fuel discharge hole: M16×1.5

Cross Ref.: 7677 955 107,
571366
Application: Scania



Drawing No.: **3407 6665 001**
Repair Kit.: **3407 6665 900**

Displacement: 16.7ml/r
Controlled flow: 15.5L/min
Max. pressure: 9MPa
Speed range: 500-3600r/min
Rotation: R
Fuel feed hole: Φ 28.5
Fuel discharge hole: M16×1.5

Application: Scania



Drawing No.: **3407 3406 001**
Repair Kit.: **3407 3406 900**

Displacement: 34ml/r
Controlled flow: 25L/min
Max. pressure: 15MPa(Without)
Speed range: 500-3600r/min
Rotation: R
Fuel feed hole: M26×1.5
Fuel discharge hole: M16×1.5

Cross Ref.: 7677 955 108,
571365
Application: Scania



SORL No.: **3407 20124 001**

Displacement: 20ml/r
Controlled flow: 17.5L/min
Max. pressure: 0MPa
Speed range: 500~3600r/min
Rotation: L
Fuel feed hole: M26×1.5
Fuel discharge hole: M16×1.5

Cross Ref: CP014.2809.104,571370
Application:



Drawing No.: **3407 3407 001**
Repair Kit.: **3407 3407 900**

Displacement: 34ml/r
Controlled flow: 25L/min
Max. pressure: 15MPa(Without)
Speed range: 500-3600r/min
Rotation: R
Fuel feed hole: M26×1.5
Fuel discharge hole: M16×1.5

Cross Ref.: 7677 955 116
Application: Scania



SORL No.: **3407 21176 001**

Displacement: 21ml/r
Controlled flow: 16L/min
Max. pressure: 0MPa
Speed range: 500~3600r/min
Rotation: R
Fuel feed hole: M26×1.5
Fuel discharge hole: M16×1.5

Cross Ref: 542 0008 10,1421272,
1457708,1308495,CP014.2812.107
Application: SCANIA P,G,R



Displacement: 21ml/r
 Controlled flow: 16L/min
 Max.pressure: 0MPa
 Speed range: 500~3600r/min
 Rotation: R
 Fuel feed hole: M26×1.5
 Fuel discharge hole: M16×1.5

Cross Ref: 542 0441 10
 (LH2107703)

SORL No.: **3407 21177 001**



Displacement: 7.2ml/r
 Controlled flow: 6L/min
 Max. pressure: 9.5MPa
 Speed range: 400-6000r/min
 Rotation: R
 Fuel feed hole: Φ17.5
 Fuel discharge hole: M16×1.5

Cross Ref: 19745
 1J0422154A

Application: POLO/ FOX /
 VOYAGE / GOLF

Drawing No.: **3407 0757 001**
 Repair Kit.:



Displacement: 21ml/r
 Controlled flow: 16L/min
 Max.pressure: 0MPa
 Speed range: 500~3600r/min
 Rotation: R
 Fuel feed hole: M26×1.5
 Fuel discharge hole: M16×1.5

Cross Ref: 1504 006,1371 404
 7685 955 787,CP143.5890.135

Application: SCANIA 113

SORL No.: **3407 21194 001**



Displacement: 8ml/r
 Controlled flow: 5.5L/min
 Max. pressure: 10MPa
 Speed range: 500-7000r/min
 Rotation: R
 Fuel feed hole: Φ16
 Fuel discharge hole: M16×1.5

Cross Ref.: 330 422 155B

Application: Volkswagen
 Santana 2000

SORL No.: **YBZ08-055/100**
 Drawing No.: **3407 0801 001**
 Repair Kit.: **3407 0801 900**



Displacement: 21ml/r
 Controlled flow: 16L/min
 Max.pressure: 14MPa
 Speed range: 500~3600r/min
 Rotation: R
 Fuel feed hole: M26×1.5
 Fuel discharge hole:

Cross Ref: 1457708,7685 955 956

Application: SCANIA F94HB,K94IB,
 L94IB,L94UB,K124EB,K124IB

SORL No.: **3407 21108 001**



Displacement: 8ml/r
 Controlled flow: 5.5L/min
 Max. pressure: 10MPa
 Speed range: 500-7000r/min
 Rotation: R
 Fuel feed hole: Φ16
 Fuel discharge hole: M16×1.5

Cross Ref.: 330 422 155A

Application: Volkswagen San-
 tana 99rookie

SORL No.: **YBZ08A-055/100**
 Drawing No.: **3407 0802 001**
 Repair Kit.: **3407 0802 900**



Displacement: 21ml/r
 Controlled flow: 18.5L/min
 Max.pressure: 13.5MPa
 Speed range: 500~3600r/min
 Rotation: L
 Fuel feed hole: M26×1.5
 Fuel discharge hole: M16×1.5

Cross Ref: CP058.1685.201,3172199

Application: Scania 4 Series, Series 94

SORL No.: **3407 21229 001**



Displacement: 8ml/r
 Controlled flow: 6.3L/min
 Max. pressure: 7.5MPa
 Speed range: 500-7000r/min
 Rotation: R
 Fuel feed hole: Φ16
 Fuel discharge hole: M16×1.5

Cross Ref.: 030 145 157D

Application: Volkswagen Jetta

SORL No.: **YBZ08J-063/075**
 Drawing No.: **3407 0810 001**
 Repair Kit.: **3407 0810 900**

Displacement: 11ml/r
 Controlled flow: 8L/min
 Max. pressure: 8.5MPa
 Speed range: 400-7000r/min
 Rotation: R
 Fuel feed hole: Φ17.5
 Fuel discharge hole: M16×1.5

Cross Ref: 377422155G

Application: VW GOL 1.0 (98...)

Drawing No.: **3407 11140 001**
 Repair Kit.:



Displacement: 11ml/r
Controlled flow: 8L/min
Max. pressure: 8.5MPa
Speed range: 400-7000r/min
Rotation: R
Fuel feed hole: $\Phi 17.5$
Fuel discharge hole: M16 \times 1.5

Drawing No.: **3407 11141 001**
Repair Kit.:

Cross Ref: 377422155E
Application: VW GOL/PARATI/SAVEIRO



Displacement: 8.3ml/r
Controlled flow: 5L/min
Max. pressure: 10.5MPa
Speed range: 500~7000r/min
Rotation: R
Fuel feed hole: $\Phi 16$
Fuel discharge hole: M16 \times 1.5

SORL No.: **3407 08140 001**

Cross Ref: ERLIN:ER-4142,114 631 0010
Application: VW LT,T4,
Crafter 2.5 TDI,T5 1.9TI



Displacement: 17ml/r
Controlled flow: 14L/min
Max. pressure: 0MPa
Speed range: 500-3600r/min
Rotation: L
Fuel feed hole: $\Phi 21$
Fuel discharge hole: 3/4-16UNF

Drawing No.: **3407 17121 001**
Repair Kit.:

Cross Ref: ZF 7673 975 821
Application: Volkes Wagen/2S2422156A



Displacement: 17ml/r
Controlled flow: 9L/min
Max. pressure: 0MPa
Speed range: 500~3600r/min
Rotation: R
Fuel feed hole: $\Phi 19$
Fuel discharge hole: 3/4-16UNF

SORL No.: **3407 17218 001**

Cross Ref: LNG:46-260
Application: Volkes Wagen Customization



Displacement: 17ml/r
Controlled flow: 9L/min
Max. pressure: 0MPa
Speed range: 500-3600r/min
Rotation: L
Fuel feed hole: $\Phi 21$
Fuel discharge hole: 3/4-16UNF

Drawing No.: **3407 17122 001**
Repair Kit.:

Cross Ref: ZF 7673 975 835
Application: Volkes Wagen/2R0145157B

Displacement: 21ml/r
Controlled flow: 9L/min
Max. pressure: 0MPa
Speed range: 500-3600r/min
Rotation: R
Fuel feed hole: $\Phi 21$
Fuel discharge hole: 3/4-16UNF

Drawing No.: **3407 21126 001**
Repair Kit.:

Cross Ref: ZF 7674 975 965
Application: Volkes Wagen/2T0145157

Displacement: 9ml/r
Controlled flow: 6L/min
Max. pressure: 9.5MPa
Speed range: 400-7000r/min
Rotation: R
Fuel feed hole: $\Phi 17.5$
Fuel discharge hole: M16 \times 1.5

Drawing No.: **3407 09112 001**
Repair Kit.:

Cross Ref: 93303404
Application: OPEL/VECTRA



Displacement: 21ml/r
Controlled flow: 17L/min
Max. pressure: 15MPa(Without)
Speed range: 500-3600r/min
Rotation: R
Fuel feed hole: $\Phi 19$
Fuel discharge hole: 3/4-16UNF-2A
Cross Ref.: 7674 975 923,
XC453A674JA
Application: VOLKSWAGEN
16.170/16.220 A 35.300

Drawing No.: **3407 2133 001**
Repair Kit.: **3407 2133 900**



Pictures And/Or OEM Part Numbers are for reference purpose only.



Drawing No.: **3407 1417 001**
Repair Kit.: **3407 1417 900**

Displacement: 14ml/r
Controlled flow: 19L/min
Max. pressure: 15MPa(Without)
Speed range: 500-3600r/min
Rotation: R
Fuel feed hole: M26×1.5
Fuel discharge hole: M18×1.5

Cross Ref.: 3255676,
LF73C/2106946
Application: Volvo



SORL No.: **YBZ16F2-160/100L**
Drawing No.: **3407 1755 001**
Repair Kit.: **3407 1755 900**

Displacement: 16ml/r
Controlled flow: 16L/min
Max. pressure: 10MPa
Speed range: 500-3600r/min
Rotation: L
Fuel feed hole: M26×1.5
Fuel discharge hole: M16×1.5

Cross Ref.: 7673 955 209
1591014, 5002281
8RA 004 412-001
8RA 004 412-007
61-22591-20, 30-024411-10
BL090, 10041900, HG142L
2.53202, CH2358
TT21.00.113
Application: Volvo

SORL No.: **YBZ16F-160/100L**
Drawing No.: **3407 1714 001**
Repair Kit.: **3407 1714 900**

Displacement: 16ml/r
Controlled flow: 16L/min
Max. pressure: 10MPa
Speed range: 500-3600r/min
Rotation: L
Fuel feed hole: M26×1.5
Fuel discharge hole: M16×1.5
Cross Ref.: 7673 955 139, 8001
451, TT21.00.063, 11962 01
534 015 8001, 2.13093
58.0008, 364 642
Application: Volvo



SORL No.: **YBZ16F2-160/135L**
Drawing No.: **3407 1716 001**
Repair Kit.: **3407 1716 900**

Displacement: 16ml/r
Controlled flow: 16L/min
Max. pressure: 13.5MPa
Speed range: 500-3600r/min
Rotation: L
Fuel feed hole: M26×1.5
Fuel discharge hole: M16×1.5
Cross Ref.: 7673 955 225,
TT21.00.005, 5 001 935,
1 589 231, 8 124 341,
8001 457, 11956 01, 2.53209
Application: Volvo B10/B12/B10R
/B12M/NL10/NL12



SORL No.: **YBZ16F3-160/120L**
Drawing No.: **3407 1717 001**
Repair Kit.: **3407 1717 900**

Displacement: 16ml/r
Controlled flow: 16L/min
Max. pressure: 12MPa
Speed range: 500-3600r/min
Rotation: L
Fuel feed hole: M26×1.5
Fuel discharge hole: M16×1.5
Cross Ref.: 7673 955 213,
TT21.00.023,19543 01, 2.10230
1587787, 5001938, 5007938
Application: Volvo



Drawing No.: **3407 1724 001**
Repair Kit.: **3407 1724 900**

Displacement: 16ml/r
Controlled flow: 16L/min
Max. pressure: 13.5MPa
Speed range: 500-3600r/min
Rotation: L
Fuel feed hole: M26×1.5
Fuel discharge hole: M16×1.5

Cross Ref.: 1 585 013,
5 001 934
8 133 047,
TT21.00.004
534 015 8002,
11955 01
2.53200,
58.0015
7673 955 211
8001 454
Application: Volvo B10M



SORL No.: **YBZ16F2-140/120L**
Drawing No.: **3407 1767 001**
Repair Kit.: **3407 1767 900**

Displacement: 16ml/r
Controlled flow: 14L/min
Max. pressure: 12MPa
Speed range: 500-3600r/min
Rotation: L
Fuel feed hole: M26×1.5
Fuel discharge hole: M16×1.5

Cross Ref.: 7673 955 219, 8001
456, 1 587 788, 1 591 098
1 610 365, 5 001 939
5 002 280, 5 003 252
9.113, HP2270, 30103
30184, 83562, T4023
598168, 945205, 11959 01
22259 01, 571247B
571247J, 571247B
571247X, 0063.00
BP102, 983562
MGB633, LP154, LP241
363702160098, 8110 16229
229923,9109,9307,17734
K150015,307.130
Application: Volvo



Displacement: 16.6ml/r
Controlled flow: 16L/min
Speed range: 500-3600r/min
Max. pressure: 13.5MPa
Rotation: L
Fuel feed hole: M26×1.5
Fuel discharge hole: M16×1.5

SORL No.: **YBZ16F3-160/135L**
Drawing No.: **3407 1741 001**
Repair Kit.: **3407 1741 900**

Cross Ref.: 1589925, 6879899,
5001933, 7673 955 202
Application: Volvo



Displacement: 21ml/r
Controlled flow: 16L/min
Max. pressure: 15MPa
Speed range: 500-3600r/min
Rotation: L
Fuel feed hole: M26×1.5
Fuel discharge hole: M18×1.5

SORL No.: **YBZ20D2A-160/150L**
Drawing No.: **3407 2130 001**
Repair Kit.: **3407 2130 900**

Cross Ref.: 0004377, 70371284
7685 955 298
Application: Volvo



Displacement: 16ml/r
Controlled flow: 16L/min
Max. pressure: 15MPa
Speed range: 500-3600r/min
Rotation: L
Fuel feed hole: M26×1.5
Fuel discharge hole: M16×1.5
Cross Ref.: 1 089 887, 8 113
174,8001 458, 2.53196
0 124 225 021, TT21.00.026
7673 955 243
Application: Volvo

SORL No.: **YBZ16F2-160/150L**
Drawing No.: **3407 1766 001**
Repair Kit.: **3407 1766 900**



Displacement: 21ml/r
Controlled flow: 24L/min
Max. pressure: 15MPa(Without)
Speed range: 500-3600r/min
Rotation: L
Fuel feed hole: M26×1.5
Fuel discharge hole: M16×1.5
Cross Ref.: 24 424 075,
85 000 769, 85 000 973,
85 103 705,85 114 317,
8001 883,7685 955 791
Application: Volvo FM9, FM12, FH16

Drawing No.: **3407 2132 001**
Repair Kit.: **3407 2132 900**



Displacement: 17ml/r
Controlled flow: 16L/min
Max. pressure: 15MPa(Without)
Speed range: 500-3600r/min
Rotation: R
Fuel feed hole: M26×1.5
Fuel discharge hole: M16×1.5
Cross Ref.: 3172193, 1628208
8113268, VT72 2108040
542 0037 10
Application: Volvo

Drawing No.: **3407 17106 001**
Repair Kit.: **3407 17106 900**



Displacement: 18.3ml/r
Controlled flow: 16L/min
Max. pressure: 0MPa
Speed range: 500-3500r/min
Rotation: R
Fuel feed hole: M26×1.5
Fuel discharge hole: M18×1.5

SORL No.:
Drawing No.: **3407 1831 001**
Repair Kit.:

Cross Ref.: ZF 7684 974 704
Application: VOLVO



Displacement: 20ml/r
Controlled flow: 15L/min
Max. pressure: 14MPa
Speed range: 500-3200r/min
Rotation: L
Fuel feed hole: 1 5/16-12UN
Fuel discharge hole: NPT3/4

SORL No.: **YBZ20C3A-150/140L**
Drawing No.: **3407 2008 001**
Repair Kit.: **3407 2008 900**

Cross Ref.: 38401 0018
V20NF1D6P38C4H20L
Application: Volvo



Displacement: 17ml/r
Controlled flow: 17L/min
Max. pressure: 0MPa
Speed range: 500-3600r/min
Rotation: L
Fuel feed hole: M26×1.5
Fuel discharge hole: M16×1.5

SORL No.:
Drawing No.: **3407 2199 001**
Repair Kit.:

Cross Ref.: ZF 8694 974 519
Application: VOLVO



Displacement: 21ml/r
Controlled flow: 21L/min
Max. pressure: 12MPa
Speed range: 500-3600r/min
Rotation: L
Fuel feed hole: M26×1.5
Fuel discharge hole: M16×1.5

SORL No.: **YBZ21F-210/120L**
Drawing No.: **3407 2101 001**
Repair Kit.: **3407 2101 900**

Cross Ref.: 8152785,
7674 955 339
Application: Volvo



Displacement: 21ml/r
Controlled flow: 24L/min
Max. pressure: 0MPa
Speed range: 500-3500r/min
Rotation: R
Fuel feed hole: M26×1.5
Fuel discharge hole: M18×1.5

SORL No.:
Drawing No.: **3407 21118 001**
Repair Kit.:

Cross Ref.: ZF 7685 974 704
Application: VOLVO

Pictures And/Or OEM Part Numbers are for reference purpose only.



Displacement: 17ml/r
 Controlled flow: 15L/min
 Max.pressure: 0MPa
 Speed range: 500~3600r/min
 Rotation: R
 Fuel feed hole: M26×1.5
 Fuel discharge hole: M18×1.5

Cross Ref: CP250.9159.195,Custom gear
 Application:

SORL No.: **3407 16629 001**



Displacement: 17.5ml/r
 Controlled flow: 16L/min
 Max.pressure: 0MPa
 Speed range: 500~3600r/min
 Rotation: L
 Fuel feed hole: M26×1.5
 Fuel discharge hole: M16×1.5
 Cross Ref: CP056.5403.209,
 Custom gear,8694 974 519,8001 106
 Application: VOLVO FM12 1998-2005,
 FM9 2001-2005

SORL No.: **3407 17173 001**



Displacement: 21ml/r
 Controlled flow: 20L/min
 Max.pressure: 0MPa
 Speed range: 500~3600r/min
 Rotation: R
 Fuel feed hole: M26×1.5
 Fuel discharge hole: M16×1.5

Cross Ref: 542 0426 10,3172488
 Application: Volvo FH12 1993-
 FM12 1998-2005

SORL No.: **3407 21115 001**



Displacement: 17.5ml/r
 Controlled flow: 16.5L/min
 Max.pressure: 0MPa
 Speed range: 500~3600r/min
 Rotation: L
 Fuel feed hole: M26×1.5
 Fuel discharge hole: M16×1.5
 Cross Ref: CP372.5778.458,7684 955
 626,21110365,7421186659
 Application: VOLVO FH,FM 05-
 FM 9 01-05,FMX 10-
 RENAULT C,D,K,T-Serie

SORL No.: **3407 17203 001**



Displacement: 21ml/r
 Controlled flow: 16L/min
 Max.pressure: 0MPa
 Speed range: 500~3600r/min
 Rotation: R
 Fuel feed hole: M26×1.5
 Fuel discharge hole: M18×1.5

Cross Ref: 542 0425 10,3172490
 Application: Volvo FH12 1993-
 FM12 1998-2005

SORL No.: **3407 21116 001**



Displacement: 21ml/r
 Controlled flow: 23.5L/min
 Max.pressure: 0MPa
 Speed range: 500~3600r/min
 Rotation: L
 Fuel feed hole: M26×1.5
 Fuel discharge hole: M16×1.5
 Cross Ref: CP378.9064.455,7685 955
 628,21488865,042415
 Application: VOLVO FH 2005-
 FM 2005-,FM 9 2001-2005

SORL No.: **3407 21198 001**



Displacement: 17.5ml/r
 Controlled flow: 17L/min
 Max.pressure: 0MPa
 Speed range: 50~3600r/min
 Rotation: L
 Fuel feed hole: M26×1.5
 Fuel discharge hole: M16×1.5

Cross Ref: 85000972,
 7684 955 763,8695 671 107,8001 872
 Application: VOLVO B9,FH,FH16,FM,FM9

SORL No.: **3407 17159 001**



Displacement: 21ml/r
 Controlled flow: 17.5L/min
 Max.pressure: 0MPa
 Speed range: 500~3600r/min
 Rotation: R
 Fuel feed hole: M26×1.5
 Fuel discharge hole: M16×1.5

Cross Ref: CP014.8752.203
 Application: VOLVO FH12,B12

SORL No.: **3407 21203 001**



Displacement: 21ml/r
 Controlled flow: 23L/min
 Max.pressure: 0MPa
 Speed range: 500~3600r/min
 Rotation: L
 Fuel feed hole: M26×1.5
 Fuel discharge hole: M16×1.5

Cross Ref: CP266.4404.
 187 Custom gear
 Application: VOLVO FH16,FM9,FM12

SORL No.: **3407 21205 001**



Displacement: 24.3ml/r
 Controlled flow: 24L/min
 Max.pressure: 0MPa
 Speed range: 500~3600r/min
 Rotation: L
 Fuel feed hole: M26×1.5
 Fuel discharge hole: M16×1.5

Cross Ref: CP266.1823.450
 Application: VOLVO FH16,FM9,FM12

SORL No.: **3407 2410 001**

Pictures And/Or OEM Part Numbers are for reference purpose only.



SORL No.: **3407 2171 001**

Displacement: 21ml/r
Controlled flow: 24L/min
Max.pressure: 0MPa
Speed range: 500~3600r/min
Rotation: L
Fuel feed hole: M26×1.5
Fuel discharge hole: M16×1.5

Cross Ref: 8694 974
505,21188993,24424074,85000768
Application: VOLVO FH16,FM9,FM12



SORL No.: **3407 2552 001**

Displacement: 25ml/r
Controlled flow: 25.5L/min
Max.pressure: 19MPa
Speed range: 500~3600r/min
Rotation: L
Fuel feed hole: M26×1.5
Fuel discharge hole: M16×1.5
Cross Ref: CP410.9979.482,
21939948,K S00 001 720,7675 955 113
Application: VOLVO 9700,9900,
2009-, FH II



SORL No.:
Cross Ref.: 44310-1561
Application: Hino EH700

Displacement: 13ml/r
Controlled flow: 8.5L/min
Max. pressure: 8MPa
Speed range: 500-3200r/min
Rotation: R
Fuel feed hole: M22×1.5
Fuel discharge hole: M16×1.5

Cross Ref.: 44310-1561
Application: Hino EH700



SORL No.: **3407 18101 001**

Displacement: 18.3ml/r
Controlled flow: 16L/min
Max.pressure: 0MPa
Speed range: 500~3600r/min
Rotation: R
Fuel feed hole: M26×1.5
Fuel discharge hole: M18×1.5
Cross Ref: CP:282.2519.182,
7684 974 704,Custom gear
Application: Volvo FH12 1993-
FM12 1998-2005



SORL No.: **YBZ14B-065/100**
Drawing No.: **3407 1404 001**
Repair Kit.: **3407 1404 900**

Displacement: 14ml/r
Controlled flow: 6.5L/min
Max. pressure: 10MPa
Speed range: 500-3600r/min
Rotation: R
Fuel feed hole: M22×1.5
Fuel discharge hole: M16×1.5

Cross Ref.: 44310-1880,
44310-1930
Application: Hino H07C

Displacement: 21ml/r
Controlled flow: 24L/min
Max.pressure: 0MPa
Speed range: 500~3600r/min
Rotation: R
Fuel feed hole: M26×1.5
Fuel discharge hole: M18×1.5

SORL No.: **3407 21244 001**

Cross Ref: CP126.4676.185 Custom gear
Application: Volvo FH12 1993-
FM12 1998-2005



SORL No.: **YBZ14D-080/080**
Drawing No.: **3407 1410 001**
Repair Kit.: **3407 1410 900**

Displacement: 14ml/r
Controlled flow: 8L/min
Max. pressure: 8MPa
Speed range: 500-3600r/min
Rotation: R
Fuel feed hole: G3/8
Fuel discharge hole: G3/8

Cross Ref.: 44300-1260B
Application: Hino EH700



SORL No.: **3407 21129 001**

Displacement: 21ml/r
Controlled flow: 24L/min
Max.pressure: 0MPa
Speed range: 500~3600r/min
Rotation: R
Fuel feed hole: M26×1.5
Fuel discharge hole: M18×1.5

Cross Ref: 7685 974 704 without gear
Application: Volvo FH12 1993-
FM12 1998-2005



SORL No.: **YBZ15E-080/080**
Drawing No.: **3407 1522 001**
Repair Kit.: **3407 1522 900**

Displacement: 15ml/r
Controlled flow: 8L/min
Max. pressure: 8MPa
Speed range: 500-3600r/min
Rotation: R
Fuel feed hole: G3/8
Fuel discharge hole: G3/8

Cross Ref.: 44300-1260B
Application: Hino

Pictures And/Or OEM Part Numbers are for reference purpose only.



SORL No.: **YBZ18-160/085**
 Drawing No.: **3407 1801 001**
 Repair Kit.: **3407 1801 900**

Displacement: 18ml/r
 Controlled flow: 16L/min
 Max. pressure: 8.5MPa
 Speed range: 500-3200r/min
 Rotation: R
 Fuel feed hole: $\Phi 12$
 Fuel discharge hole: RC3/8

Cross Ref.: 44310-1430
 Application: Hino ED100R



SORL No.:
 Drawing No.: **3407 1873 001**
 Repair Kit.:

Displacement: 17.5ml/r
 Controlled flow: 16L/min
 Max. pressure: 14MPa
 Speed range: 500-3200 r/min
 Rotation: R
 Fuel feed hole: $\Phi 23.7$
 Fuel discharge hole: M16 \times 1.5

Cross Ref.: 44310-1772
 Application: Hino P11C



SORL No.: **YBZ18-160/100**
 Drawing No.: **3407 1802 001**
 Repair Kit.: **3407 1802 900**

Displacement: 18ml/r
 Controlled flow: 16L/min
 Max. pressure: 8.5MPa
 Speed range: 500-3200r/min
 Rotation: R
 Fuel feed hole: $\Phi 12$
 Fuel discharge hole: RC3/8

Cross Ref.: 44310-1200
 Application: Hino ED100R



SORL No.: **YBZ20F2-200/130**
 Drawing No.: **3407 2017 001**
 Repair Kit.: **3407 2017 900**

Displacement: 20ml/r
 Controlled flow: 20L/min
 Max. pressure: 13MPa
 Speed range: 500-3500r/min
 Rotation: R
 Fuel feed hole: $\Phi 12$
 Fuel discharge hole: M16 \times 1.5

Cross Ref.: 44300-1641
 Application: Hino EF750



SORL No.: **YBZ18F-140/085**
 Drawing No.: **3407 1807 001**
 Repair Kit.: **3407 1807 900**

Displacement: 18ml/r
 Controlled flow: 14L/min
 Max. pressure: 8.5MPa
 Speed range: 500-4000r/min
 Rotation: R
 Fuel feed hole: $\Phi 22$
 Fuel discharge hole: M22 \times 1.5

Cross Ref.: 44310-1490
 Application: Hino EK100



SORL No.:
 Drawing No.: **3407 2804 001**
 Repair Kit.:

Displacement: 28ml/r
 Controlled flow: 17L/min
 Max. pressure: 14MPa
 Speed range: 500-3200 r/min
 Rotation: R
 Fuel feed hole: $\Phi 27$
 Fuel discharge hole: M16 \times 1.5

Cross Ref.: 44350-1610
 Application: Hino P11C(new)



SORL No.:
 Drawing No.: **3407 1871 001**
 Repair Kit.:

Displacement: 17.5ml/r
 Controlled flow: 16L/min
 Max. pressure: 13MPa
 Speed range: 500-3200 r/min
 Rotation: R
 Fuel feed hole: $\Phi 24.7$
 Fuel discharge hole: M16 \times 1.5

Cross Ref.: 44310-1490
 44310-1621
 Application: Hino EK100/EM100



SORL No.:
 Drawing No.: **3407 2084 001**
 Repair Kit.:

Displacement: 20ml/r
 Controlled flow: 16L/min
 Max. pressure: 13MPa
 Speed range: 500-3500 r/min
 Rotation: L
 Fuel feed hole: $\Phi 20$
 Fuel discharge hole: M16 \times 1.5

Cross Ref.: 44310-2790
 Application: Hino J08C



SORL No.:
 Drawing No.: **3407 1872 001**
 Repair Kit.:

Displacement: 17.5ml/r
 Controlled flow: 16L/min
 Max. pressure: 13MPa
 Speed range: 500-3200 r/min
 Rotation: R
 Fuel feed hole: $\Phi 24.7$
 Fuel discharge hole: M16 \times 1.5

Cross Ref.:
 Application: Hino EM100-B



SORL No.:
 Drawing No.: **3407 2098 001**
 Repair Kit.:

Displacement: 20ml/r
 Controlled flow: 18L/min
 Max. pressure: 13MPa
 Speed range: 500-3500 r/min
 Rotation: R
 Fuel feed hole: $\Phi 20$
 Fuel discharge hole: M16 \times 1.5

Cross Ref.: 44350-1570
 Application: Hino J08E



SORL No.:
Drawing No.: **3407 11153 001**
Repair Kit:

Displacement: 11ml/r
Controlled flow: 7L/min
Max. pressure: 8.5MPa
Speed range: 500-3600 r/min
Rotation: R
Fuel feed hole: M22×1.5
Fuel discharge hole: M16×1.5

Cross Ref.: 44310-1901
44310-1881
Application: Hino H06CT/H07D



SORL No.: **3407 2819 001**

Displacement: 28ml/r
Controlled flow: 24L/min
Max. pressure: 15MPa
Speed range: 500~3600r/min
Rotation: L
Fuel feed hole: Φ23.7
Fuel discharge hole: M16×1.5

Cross Ref: 44310-2500
Application: HINO TRUCK,HINO P11C



SORL No.:
Drawing No.: **3407 14117 001**
Repair Kit:

Displacement: 14.5ml/r
Controlled flow: 17L/min
Max. pressure: 13MPa
Speed range: 500-3600 r/min
Rotation: L
Fuel feed hole: Φ29.3
Fuel discharge hole: M16×1.5

Cross Ref.: 44350-1340
44350-1341
Application: Hino J05C-A



SORL No.: **3407 14195 001**

Displacement: 15ml/r
Controlled flow: 16L/min
Max. pressure: 13MPa
Speed range: 500~3600r/min
Rotation: L
Fuel feed hole: M20×1.5
Fuel discharge hole: M16×1.5

Cross Ref: 44310-2362,44310-2322
Application: HINO J08C



Drawing No.: **3407 09113 001**
Repair Kit:

Displacement: 8.9ml/r
Controlled flow: 8.5L/min
Max. pressure: 8.5MPa
Speed range: 400-3600r/min
Rotation: R
Fuel feed hole: Φ19.2
Fuel discharge hole: Φ18

Cross Ref: 56100-RNA-A030
Application: Honda Civic 2006-2011



SORL No.: **3407 2812 001**

Displacement: 28ml/r
Controlled flow: 17L/min
Max. pressure: 14.7MPa
Speed range: 500~3600r/min
Rotation: R
Fuel feed hole: Φ28
Fuel discharge hole: M16×1.5

Cross Ref: 44310-E0310
Application: E13C 14714-99020,EV700



Drawing No.: **3407 1057 001**
Repair Kit: **3407 1057 900**

Displacement: 10ml/r
Controlled flow: 7.6L/min
Max. pressure: 7MPa
Speed range: 400-7000r/min
Rotation: R
Fuel feed hole: Φ16.2
Fuel discharge hole: Φ18
Cross Ref.: 56100-PZD-A01
56100-PNB-A02

Application: 03-04 Honda CR-V
03-05 Honda Element



SORL No.: **3407 2818 001**

Displacement: 28ml/r
Controlled flow: 24L/min
Max. pressure: 13MPa
Speed range: 500~3600r/min
Rotation: R
Fuel feed hole: Φ17
Fuel discharge hole: M16×1.5

Cross Ref: 44310-2250
Application: HINO TRUCK,HINO P11C



Drawing No.: **3407 1207 001**
Repair Kit: **3407 1207 900**

Displacement: 12ml/r
Controlled flow: 5.6L/min
Max. pressure: 7.6MPa
Speed range: 400-7000r/min
Rotation: L
Fuel feed hole: Φ18
Fuel discharge hole: Φ18

Cross Ref.: 56110-PAA-A01
Application: 98-02 Honda Accord 4cyl



Drawing No.: **3407 1209 001**
Repair Kit.: **3407 1209 900**

Displacement: 12ml/r
Controlled flow: 7.5L/min
Max. pressure: 9MPa
Speed range: 400-7000r/min
Rotation: R
Fuel feed hole: Φ 16.2
Fuel discharge hole: Φ 18

Cross Ref.: 56100-P8C-A01
Application: 98-02 Honda Accord 6cyl



SORL No.: **3407 1250 001**

Displacement: 7.5ml/r
Controlled flow: 7.6L/min
Max. pressure: 8MPa
Speed range: 500~6000r/min
Rotation: R
Fuel feed hole: Φ 18
Fuel discharge hole: ϕ 18

Cross Ref: 5557,990-0472,21-5993
Application: 2002-1998 Honda Accord



SORL No.: **3407 09136 001**

Displacement: 8.9ml/r
Controlled flow: 8.5L/min
Max. pressure: 8.5MPa
Speed range: 500~6000r/min
Rotation: R
Fuel feed hole: Φ 19.2
Fuel discharge hole: Φ 18

Cross Ref: 56100-RNA-A01,W,O pulley
Application: Honda Civic 2006-2011



Drawing No.: **3407 1212 001**
Repair Kit.: **3407 1212 900**

Displacement: 12ml/r
Controlled flow: 7.6L/min
Max. pressure: 7.6MPa
Speed range: 400-7000r/min
Rotation: R
Fuel feed hole: Φ 16.2
Fuel discharge hole: Φ 12

Cross Ref.: 56110-P5A-003
Application: 96-04 Honda Acura
RL 97-98 Honda Acura TL



SORL No.: **3407 10146 001**

Displacement: 8.7ml/r
Controlled flow: 5.8L/min
Max. pressure: 8.5MPa
Speed range: 500~6000r/min
Rotation: R
Fuel feed hole: Φ 18.2
Fuel discharge hole: ϕ 18

Cross Ref: 56110-RAA-A01,821H
Application: HONDA



SORL No.: **3407 10149 001**

Displacement: 10.6ml/r
Controlled flow: 7.9L/min
Max. pressure: 9MPa
Speed range: 500~6000r/min
Rotation: R
Fuel feed hole: Φ 18
Fuel discharge hole: ϕ 18

Cross Ref: 5760,56110-RCA-A01
Application: HONDA



Drawing No.: **3407 1208 001**
Repair Kit.: **3407 1208 900**

Displacement: 12ml/r
Controlled flow: 7.5L/min
Max. pressure: 8MPa
Speed range: 400-7000r/min
Rotation: R
Fuel feed hole: Φ 14
Fuel discharge hole: M12 \times 1.25

Cross Ref.: 49110-6P010
Application: 97-98 Infiniti Q45



SORL No.: **3407 1249 001**

Displacement: 12.2ml/r
Controlled flow: 7.6L/min
Max. pressure: 8.5MPa
Speed range: 500~6000r/min
Rotation: R
Fuel feed hole: Φ 18
Fuel discharge hole: ϕ 18

Cross Ref: 5339,SP15557,36-215339
990-0235
Application: 2002-1998 Honda Accord 6 Cyl.



Drawing No.: **3407 1213 001**
Repair Kit.: **3407 1213 900**

Displacement: 12ml/r
Controlled flow: 7.5L/min
Max. pressure: 8MPa
Speed range: 400-7000r/min
Rotation: R
Fuel feed hole: Φ 14
Fuel discharge hole: M12 \times 1.25

Cross Ref.: 49110-7P000
Application: 98-01 Infiniti Q45



SORL No.: **3407 1091 001**

Displacement: 9.6ml/r
Controlled flow: 7.6L/min
Max.pressure: 8MPa
Speed range: 500~6000r/min
Rotation: R
Fuel feed hole: $\Phi 15$
Fuel discharge hole: M16 \times 1.5

Cross Ref: 21-5221,49110-7J400,5567
Application: INFINITI G20 2.0L L4



SORL No.: **3407 10117 001**

Displacement: 9.6ml/r
Controlled flow: 7.6L/min
Max.pressure: 8MPa
Speed range: 500~6000r/min
Rotation: R
Fuel feed hole: $\Phi 15$
Fuel discharge hole: M16 \times 1.5

Cross Ref: 5567
Application: INFINITI G20 2.0L L4



SORL No.: **YBZ07Y-075/095**
Drawing No.: **3407 0712 001**
Repair Kit.: **3407 0712 900**

Displacement: 7.4ml/r
Controlled flow: 7.5L/min
Max. pressure: 9.5MPa
Speed range: 500-6000r/min
Rotation: R
Fuel feed hole: $\Phi 15$
Fuel discharge hole: M12 \times 1.25

Cross Ref.: 8-97331 940-0
Application: Isuzu



SORL No.: **3407 08105 001**

Displacement: 8.5ml/r
Controlled flow: 7.9L/min
Max.pressure: 9MPa
Speed range: 400~7000r/min
Rotation: R
Fuel feed hole: $\Phi 16$
Fuel discharge hole: M16 \times 1.5

Cross Ref: 21-237,5885, 49110-EG000,49110-JK000
Application: INFINITI M35 3.5L V6



SORL No.:
Drawing No.: **3407 0751 001**
Repair Kit.:

Displacement: 7ml/r
Controlled flow: 8L/min
Max. pressure: 10MPa
Speed range: 500-5000r/min
Rotation: L
Fuel feed hole: $\Phi 17.5$
Fuel discharge hole: M12 \times 1.25

Cross Ref.: 897115134
1-897115-135-0
Application: ISUZU 4HF1



SORL No.: **3407 1092 001**

Displacement: 9.6ml/r
Controlled flow: 7L/min
Max.pressure: 10MPa
Speed range: 400~7000r/min
Rotation: R
Fuel feed hole: $\Phi 16$
Fuel discharge hole: M16 \times 1.5

Cross Ref: 21-5412,5880, 49110-CG000
Application: INFINITI FX35 3.5L V6 2003



SORL No.:
Drawing No.: **3407 0760 001**
Repair Kit.:

Displacement: 7.2ml/r
Controlled flow: 7L/min
Max. pressure: 10MPa
Speed range: 500-5000r/min
Rotation: R
Fuel feed hole: $\Phi 17.5$
Fuel discharge hole: M16 \times 1.5

Cross Ref.: 8-97084-207-0
Application: ISUZU 4JB1-A



SORL No.: **3407 10122 001**

Displacement: 9.7ml/r
Controlled flow: 7.5L/min
Max.pressure: 8.5MPa
Speed range: 400~7000r/min
Rotation: R
Fuel feed hole: $\Phi 16$
Fuel discharge hole: M16 \times 1.5

Cross Ref: 96-394
Application: Infiniti family 2007-2017



Drawing No.: **3407 1127 001**
Repair Kit.: **3407 1127 900**

Displacement: 11ml/r
Controlled flow: 8.5L/min
Max. pressure: 10MPa
Speed range: 500-7000r/min
Rotation: L
Fuel feed hole: $\Phi 16$
Fuel discharge hole: M16 \times 1.5

Cross Ref.: 46-012 , Lfv30
Application: Isuzu



Displacement: 12ml/r
 Controlled flow: 10L/min
 Max. pressure: 10MPa
 Speed range: 500-3200r/min
 Rotation: R
 Fuel feed hole: $\Phi 11$
 Fuel discharge hole: G 3/8

SORL No.:
 Drawing No.: **3407 1239 001**
 Repair Kit:

Cross Ref.: 44306-1160Q
 Application: ISUZU 4BC2(NEW)/4BE1



Displacement: 30ml/r
 Controlled flow: 18L/min
 Max. pressure: 14MPa
 Speed range: 500~3600r/min
 Rotation: R
 Fuel feed hole: $\Phi 14$
 Fuel discharge hole: 3/4-16UNF

SORL No.: **3407 3025 001**

Cross Ref: Z605B:00347, with gear
 Application: ISUZU



Displacement: 11.4ml/r
 Controlled flow: 11L/min
 Max. pressure: 14MPa
 Speed range: 500~6000r/min
 Rotation: L
 Fuel feed hole: $\Phi 14$
 Fuel discharge hole: M20 \times 1.5

SORL No.: **3407 11335 001**

Cross Ref: 4HK1,470-04169,
 119500635
 Application: ISUZU



Displacement: 30ml/r
 Controlled flow: 18L/min
 Max. pressure: 14MPa
 Speed range: 500~3600r/min
 Rotation: R
 Fuel feed hole: $\Phi 14$
 Fuel discharge hole: M18 \times 1.5

SORL No.: **3407 3027 001**

Cross Ref: 488-00112, 119500614,
 488-00117, 897481552
 Application: ISUZU 6WF1, HITACHI



Displacement: 11.4ml/r
 Controlled flow: 11L/min
 Max. pressure: 14MPa
 Speed range: 500~6000r/min
 Rotation: L
 Fuel feed hole: $\Phi 14$
 Fuel discharge hole: G 3/8

SORL No.: **3407 11339 001**

Cross Ref: 4HK1,470-
 04170, 119500538, 1-19500636-1
 Application: ISUZU



Displacement: 18ml/r
 Controlled flow: 12L/min
 Max. pressure: 10MPa
 Speed range: 500-3600r/min
 Rotation: R
 Fuel feed hole: $\Phi 12$
 Fuel discharge hole: M18 \times 1.5

SORL No.: **YBZ18A-120/100**
 Drawing No.: **3407 1803 001**
 Repair Kit: **3407 1803 900**

Cross Ref.: 19500-371,
 475-04080, 475-04065,
 475-03914
 Application: Isuzu 6BG1



Displacement: 21ml/r
 Controlled flow: 18L/min
 Max. pressure: 13MPa
 Speed range: 500~3600r/min
 Rotation: L
 Fuel feed hole: $\Phi 12$
 Fuel discharge hole: M18 \times 1.5C

SORL No.: **3407 21222 001**

Cross Ref:
 Application: ISUZU DEGA270 6SD



Displacement: 20ml/r
 Controlled flow: 18L/min
 Max. pressure: 12.5MPa
 Speed range: 500-3600r/min
 Rotation: R
 Fuel feed hole: M26 \times 1.5
 Fuel discharge hole: M18 \times 1.5

SORL No.: **YBZ20F4-180/125**
 Drawing No.: **3407 2022 001**
 Repair Kit: **3407 2022 900**

Cross Ref.: 65.47101-7029, B3
 65.47101-6041, 65.47101-6040,
 Application: Isuzu



Displacement: 25ml/r
 Controlled flow: 17L/min
 Max. pressure: 13MPa
 Speed range: 500~3600r/min
 Rotation: L
 Fuel feed hole: $\Phi 16$
 Fuel discharge hole: M18 \times 1.5

SORL No.: **3407 2535 001**

Cross Ref: 0211-0225, 6UZ1
 Application: IS DEGA360+6UZ



Displacement: 20ml/r
 Controlled flow: 16L/min
 Max. pressure: 10MPa
 Speed range: 500-3600r/min
 Rotation: L
 Fuel feed hole: $\Phi 12$
 Fuel discharge hole: M18 \times 1.5

SORL No.: **YBZ20-160/100L**
 Drawing No.: **3407 2108 001**
 Repair Kit: **3407 2108 900**

Cross Ref.: 475-05024,
 475-05047, 19500-351
 Application: Isuzu 6SA1

Pictures And/Or OEM Part Numbers are for reference purpose only.



SORL No.:
Drawing No.: **3407 10101 001**
Repair Kit.:

Displacement: 9ml/r
Controlled flow: 7L/min
Max. pressure: 8.5MPa
Speed range: 500-3600r/min
Rotation: L
Fuel feed hole: $\Phi 17$
Fuel discharge hole: M16 \times 1.5

Cross Ref.: 470-04156
Application: ISUZU 6HH1



SORL No.:
Drawing No.: **3407 10102 001**
Repair Kit.:

Displacement: 9ml/r
Controlled flow: 9L/min
Max. pressure: 8.5MPa
Speed range: 500-3600r/min
Rotation: L
Fuel feed hole: $\Phi 17$
Fuel discharge hole: M18 \times 1.5

Cross Ref.:
Application: ISUZU 6HE1(3 Hole)



Drawing No.: **3407 08114 001**
Repair Kit.:

Displacement: 8.3ml/r
Controlled flow: 6.5L/min
Max. pressure: 7MPa
Speed range: 400-7000r/min
Rotation: R
Fuel feed hole: $\Phi 16.7$
Fuel discharge hole: M12 \times 1.25-6g

Cross Ref: MR374897
Application: Mitsubishi L-300/L-200



SORL No.:
Drawing No.: **3407 21133 001**
Repair Kit.:

Displacement: 20ml/r
Controlled flow: 18L/min
Max. pressure: 13MPa
Speed range: 500-3200r/min
Rotation: L
Fuel feed hole: $\Phi 12$
Fuel discharge hole: M18 \times 1.5

Cross Ref.: 19500-351,475-0524
475-0547
Application: ISUZU 6SA1



Drawing No.: **3407 1022 001**
Repair Kit.: **3407 1022 900**

Displacement: 10ml/r
Controlled flow: 10L/min
Max. pressure: 11.5MPa
Speed range: 400-7000r/min
Rotation: R
Fuel feed hole: $\Phi 14.5$
Fuel discharge hole: M16 \times 1.5

Application: 06-07 Mitsubishi Raider



Drawing No.: **3407 2702 001**
Repair Kit.:

Displacement: 26ml/r
Controlled flow: 17L/min
Max. pressure: 13MPa
Speed range: 500-3600r/min
Rotation: R
Fuel feed hole: $\Phi 12$
Fuel discharge hole: M18 \times 1.5

Cross Ref: 1-19500561-0
Application: ISUZU 6WA1/6WF1



Drawing No.: **3407 1025 001**
Repair Kit.: **3407 1025 900**

Displacement: 10ml/r
Controlled flow: 7.2L/min
Max. pressure: 9MPa
Speed range: 500-7000r/min
Rotation: R
Fuel feed hole: $\Phi 16$
Fuel discharge hole: M16 \times 1.5
Cross Ref.: MN184180, MR589339
Application: 06-12 Mitsubishi Eclipse
04-09 Mitsubishi Galant
04-11 Mitsubishi Endeavor



Drawing No.: **3407 2703 001**
Repair Kit.:

Displacement: 26ml/r
Controlled flow: 16L/min
Max. pressure: 13MPa
Speed range: 500-3600r/min
Rotation: L
Fuel feed hole: $\Phi 12$
Fuel discharge hole: M18 \times 1.5

Application: ISUZU 6SD1



Drawing No.: **3407 1042 001**
Repair Kit.: **3407 1042 900**

Displacement: 10ml/r
Controlled flow: 6.2L/min
Max. pressure: 8.5MPa
Speed range: 500-7000r/min
Rotation: R
Fuel feed hole: $\Phi 16$
Fuel discharge hole: M16 \times 1.5

Cross Ref.: MN101061, 4526A008
Application: 06-12 Mitsubishi Eclipse
04-11 Mitsubishi Galant



SORL No.: **YBZ15B-120/120**
 Drawing No.: **3407 1504 001**
 Repair Kit.: **3407 1504 900**

Displacement: 15ml/r
 Controlled flow: 12L/min
 Max. pressure: 12MPa
 Speed range: 500-3600r/min
 Rotation: R
 Fuel feed hole: $\Phi 18$
 Fuel discharge hole: M20 \times 1.5

Cross Ref.: MC092059, 475-03479
 Application: FUSO 6D16, JKC2419



Drawing No.: **3407 2097 001**
 Repair Kit.:

Displacement: 21ml/r
 Controlled flow: 17L/min
 Max. pressure: 12.5MPa
 Speed range: 500-3500r/min
 Rotation: R
 Fuel feed hole: $\Phi 23$
 Fuel discharge hole: 3/4-16UNF

Application: Mitsubishi Fuso 8DC9



SORL No.: **YBZ15B-120/120L**
 Drawing No.: **3407 1505 001**
 Repair Kit.: **3407 1505 900**

Displacement: 15ml/r
 Controlled flow: 12L/min
 Max. pressure: 12MPa
 Speed range: 500-3600r/min
 Rotation: R
 Fuel feed hole: $\Phi 18$
 Fuel discharge hole: M20 \times 1.5
 Cross Ref.: MC092058,
 475-03478

Application: FUSO 6D14,
 6D15, JKC3418



SORL No.: **3407 20119 001**

Displacement: 21ml/r
 Controlled flow: 17L/min
 Max. pressure: 12.5MPa
 Speed range: 500~3600r/min
 Rotation: R
 Fuel feed hole: $\Phi 23$
 Fuel discharge hole: 3/4-16UNF

Cross Ref: MC826183
 Application:



SORL No.:
 Drawing No.: **3407 1585 001**
 Repair Kit.:

Displacement: 15ml/r
 Controlled flow: 16L/min
 Max. pressure: 14MPa
 Speed range: 500-3200r/min
 Rotation: R
 Fuel feed hole: M20 \times 1.5
 Fuel discharge hole: M20 \times 1.5

Cross Ref.: 475-03451
 Application: MITSUBISHI FUSO 6D16



SORL No.:
 Drawing No.: **3407 1586 001**
 Repair Kit.:

Displacement: 15ml/r
 Controlled flow: 11L/min
 Max. pressure: 10MPa
 Speed range: 500-3200r/min
 Rotation: L
 Fuel feed hole: M20 \times 1.5
 Fuel discharge hole: M20 \times 1.5

Cross Ref.: 475-03423
 475-03478
 Application: MITSUBISHI FUSO 6D14/6D15



SORL No.: **3407 0775 001**

Displacement: 7.4ml/r
 Controlled flow: 6.4L/min
 Max. pressure: 8.5MPa
 Speed range: 500~6000r/min
 Rotation: R
 Fuel feed hole: $\Phi 16$
 Fuel discharge hole: M16 \times 1.5
 Cross Ref: 96-5285,21-5285,
 49110-4M800
 Application: NISSAN,
 SENTRA 2.0L L4 2000-2001



Drawing No.: **3407 2096 001**
 Repair Kit.:

Displacement: 21ml/r
 Controlled flow: 17L/min
 Max. pressure: 12.5MPa
 Speed range: 500-3500r/min
 Rotation: R
 Fuel feed hole: $\Phi 23$
 Fuel discharge hole: 3/4-16UNF

Application: Mitsubishi Fuso 6D22



Displacement: 11.9ml/r
 Controlled flow: 7.6L/min
 Max. pressure: 8MPa
 Speed range: 500~6000r/min
 Rotation: R
 Fuel feed hole: $\Phi 15$
 Fuel discharge hole: M16 \times 1.5
 Cross Ref: 5575.49110-4S100
 Application: 2004-1999
 Nissan Trucks Frontier 3.3 Liters
 2004-2000 Nissan Trucks
 Xterra 3.3 Liters"



Displacement: 9.7ml/r
 Controlled flow: 9.5L/min
 Max.pressure: 9MPa
 Speed range: 500~6000r/min
 Rotation: R
 Fuel feed hole: $\Phi 15$
 Fuel discharge hole: M16 \times 1.5
 Cross Ref: 5892,49110-1AA0A
 Application: 2012-2007 Nissan Altima 3.5
 Liters 6 Cyl.,2013-2009 Nissan
 Maxima,2013-2009 Nissan Trucks Murano

SORL No.: **3407 10107 001**



Displacement: 7ml/r
 Controlled flow: 5.6L/min
 Max. pressure: 7MPa
 Speed range: 400-8000r/min
 Rotation: R
 Fuel feed hole: $\Phi 14$
 Fuel discharge hole: M14 \times 1.5

Drawing No.: **3407 0718 001**
 Repair Kit.: **3407 0718 900**

Application: Nissan



Displacement: 9.7ml/r
 Controlled flow: 6.6L/min
 Max.pressure: 9.5MPa
 Speed range: 500~6000r/min
 Rotation: R
 Fuel feed hole: $\Phi 18$
 Fuel discharge hole: M18 \times 1.5

SORL No.: **3407 10150 001**

Cross Ref: 96-5933
 Application: INFINITI,NISSAN 04-95

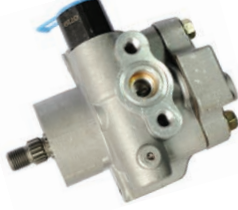

Displacement: 7ml/r
 Controlled flow: 7.5L/min
 Max. pressure: 7MPa
 Speed range: 400-8000r/min
 Rotation: R
 Fuel feed hole: $\Phi 14$
 Fuel discharge hole: M14 \times 1.5

Drawing No.: **3407 0719 001**
 Repair Kit.: **3407 0719 900**

Application: Nissan



Displacement: 13ml/r
 Controlled flow: 13L/min
 Max.pressure: 10.5MPa
 Speed range: 500~3600r/min
 Rotation: L
 Fuel feed hole: $\Phi 12$
 Fuel discharge hole: M16 \times 1.5

SORL No.: **3407 1347 001**

Cross Ref: 14670-97163
 Application: NISSAN



Displacement: 8.8ml/r
 Controlled flow: 7.8L/min
 Max. pressure: 10MPa
 Speed range: 400-8000r/min
 Rotation: R
 Fuel feed hole: $\Phi 14$
 Fuel discharge hole: M16 \times 1.5

Drawing No.: **3407 0846 001**
 Repair Kit.: **3407 0846 900**

Cross Ref.: 36-717171
 Application: Nissan



Displacement: 27ml/r
 Controlled flow: 17L/min
 Max.pressure: 13MPa
 Speed range: 500~3600r/min
 Rotation: R
 Fuel feed hole: $\Phi 28$
 Fuel discharge hole: M16 \times 1.5

SORL No.: **3407 2704 001**

Cross Ref: RG8,475-03296,
 14670-97403
 Application: NISSAN



Displacement: 9.6ml/r
 Controlled flow: 7L/min
 Max. pressure: 8MPa
 Speed range: 400-8000r/min
 Rotation: R
 Fuel feed hole: $\Phi 15$
 Fuel discharge hole: M16 \times 1.5
 Cross Ref.: HA982610074,
 49110-4S100

Drawing No.: **3407 1020 001**
 Repair Kit.: **3407 1020 900**

Application:99-04 Nissan/Datsun Xterra 4WD



Displacement: 28ml/r
 Controlled flow: 19L/min
 Max.pressure: 13MPa
 Speed range: 500~3600r/min
 Rotation: R
 Fuel feed hole: $\Phi 28$
 Fuel discharge hole: M20 \times 1.5

SORL No.: **3407 2810 001**

Cross Ref: 00Z08(NPSK-28037)
 353G 851
 Application: NISSAN



Displacement: 9.6ml/r
 Controlled flow: 6L/min
 Max. pressure: 7.5MPa
 Speed range: 400-8000r/min
 Rotation: R
 Fuel feed hole: $\Phi 14$
 Fuel discharge hole: M16 \times 1.5

Drawing No.: **3407 1021 001**
 Repair Kit.: **3407 1021 900**

Cross Ref.: C050320653,
 49110-4S100
 Application: 99-04 Nissan Frontier
 00-04 Nissan Xterra

Pictures And/Or OEM Part Numbers are for reference purpose only.



Drawing No.: **3407 1044 001**
Repair Kit.: **3407 1044 900**

Displacement: 9.6ml/r
Controlled flow: 7.6L/min
Max. pressure: 9.5MPa
Speed range: 400-7000r/min
Rotation: R
Fuel feed hole: $\Phi 16$
Fuel discharge hole: M16 \times 1.5
Cross Ref.: 49110-JA100,
49110-ZX70A,
49110-1AA0A, 49110-9N00A
Application: 07-12 Nissan Altima
09-13 Nissan Maxima
09-13 Nissan Murano



SORL No.:
Drawing No.: **3407 2085 001**
Repair Kit.:

Displacement: 20ml/r
Controlled flow: 18L/min
Max. pressure: 13.5MPa
Speed range: 500-3600r/min
Rotation: R
Fuel feed hole: $\Phi 12$
Fuel discharge hole: 3/4-16UNF

Cross Ref.: 14670-96264
14670-96277
Application: NISSAN CW520(R)PF6-1



SORL No.: **YBZ20F1-180/135**
Drawing No.: **3407 2013 001**
Repair Kit.: **3407 2013 900**

Displacement: 20ml/r
Controlled flow: 18L/min
Max. pressure: 13.5MPa
Speed range: 500-3500r/min
Rotation: R
Fuel feed hole: $\Phi 12$
Fuel discharge hole: 3/4-16UNF

Cross Ref.: 14670-96264
Application: Nissan CW520(R)PF6



SORL No.:
Drawing No.: **3407 2086 001**
Repair Kit.:

Displacement: 20ml/r
Controlled flow: 18L/min
Max. pressure: 13.5MPa
Speed range: 500-3600r/min
Rotation: R
Fuel feed hole: $\Phi 12$
Fuel discharge hole: 3/4-16UNF

Cross Ref.: 14670-96063
Application: NISSAN CW54(R)PE6-3



SORL No.: **YBZ20F1-180/135L**
Drawing No.: **3407 2014 001**
Repair Kit.: **3407 2014 900**

Displacement: 20ml/r
Controlled flow: 18L/min
Max. pressure: 13.5MPa
Speed range: 500-3500r/min
Rotation: L
Fuel feed hole: $\Phi 12$
Fuel discharge hole: 3/4-16UNF
Cross Ref.: 14670-97312,
14670-96367
Application: Nissan CW520(L)
PE6,RF8



SUBARU



SORL No.: **YBZ20F1A-180/135**
Drawing No.: **3407 2015 001**
Repair Kit.: **3407 2015 900**

Displacement: 20ml/r
Controlled flow: 18L/min
Max. pressure: 13.5MPa
Speed range: 500-3500r/min
Rotation: R
Fuel feed hole: $\Phi 12$
Fuel discharge hole: 3/4-16UNF

Cross Ref.: 14670-96063
Application: Nissan CW520(R)PE6



Drawing No.: **3407 0721 001**
Repair Kit.: **3407 0721 900**

Displacement: 7.4ml/r
Controlled flow: 5.6L/min
Max. pressure: 9.5MPa
Speed range: 500-7000r/min
Rotation: R
Fuel feed hole: $\Phi 14.5$
Fuel discharge hole: M16 \times 1.5
Cross Ref.: 34430-AE04A,
34401-AE03B
Application: 00-04 Subaru Legacy
00-04 Subaru Outback
03-06 Subaru Baja



SORL No.: **YBZ20F1A-180/135L**
Drawing No.: **3407 2016 001**
Repair Kit.: **3407 2016 900**

Displacement: 20ml/r
Controlled flow: 18L/min
Max. pressure: 13.5MPa
Speed range: 500-3500r/min
Rotation: L
Fuel feed hole: $\Phi 12$
Fuel discharge hole: 3/4-16UNF

Cross Ref.: 14670-97178,
14670-97361



SUZUKI



Drawing No.: **3407 0911 001**
Repair Kit.: **3407 0911 900**

Displacement: 9ml/r
Controlled flow: 9.5L/min
Max. pressure: 7.5MPa
Speed range: 400-7000r/min
Rotation: R
Fuel feed hole: $\Phi 16$
Fuel discharge hole: M16 \times 1.5

Cross Ref.: 49110-85Z00
Application: 04-07 Suzuki
Forenza 05-07 Suzuki Reno



Drawing No.: **3407 08109 001**
Repair Kit.:

Displacement: 8.2ml/r
Controlled flow: 7L/min
Max. pressure: 8.5MPa
Speed range: 400-7000r/min
Rotation: R
Fuel feed hole: $\Phi 17.5$
Fuel discharge hole: M16 \times 1.5

Cross Ref: 44310-35610
44310-0K040
Application: TOYOTA HILUX 1KD ORIGINAL



Drawing No.: **3407 0962 001**
Repair Kit.: **3407 0962 900**

Displacement: 9ml/r
Controlled flow: 8.7L/min
Max. pressure: 7.5MPa
Speed range: 400-7000r/min
Rotation: R
Fuel feed hole: $\Phi 16$
Fuel discharge hole: M16 \times 1.5
Cross Ref.: 49110-85Z01,
49110-85Z02, 49110-85Z10,
49110-85Z11
Application: Suzuki



Drawing No.: **3407 08122 001**
Repair Kit.:

Displacement: 8.5ml/r
Controlled flow: 4.7L/min
Max. pressure: 7MPa
Speed range: 400-7000r/min
Rotation: R
Fuel feed hole: $\Phi 14.5$
Fuel discharge hole: M16 \times 1.5

Cross Ref: 44320-16201
Application: TOYOTA PASEO L4(1992-1996)
TERCEL 1.5 L4(1991-1996)/1.5L4



SORL No.: **3407 09118 001**

Displacement: 9.3ml/r
Controlled flow: 9.1L/min
Max. pressure: 8MPa
Speed range: 500~6000r/min
Rotation: R
Fuel feed hole: $\Phi 16$
Fuel discharge hole: M16 \times 1.5

Cross Ref: 5621V
Application: SUZUKI:2005,2008



Drawing No.: **3407 0855 001**
Repair Kit.: **3407 0855 900**

Displacement: 8.8ml/r
Controlled flow: 8L/min
Max. pressure: 7.5MPa
Speed range: 400-7000r/min
Rotation: R
Fuel feed hole: $\Phi 16.5$
Fuel discharge hole: M16 \times 1.5

Cross Ref.: 11501-53121, Y9B 01602
Application: Toyota 3L



TOYOTA



Drawing No.: **3407 0945 001**
Repair Kit.: **3407 0945 900**

Displacement: 9ml/r
Controlled flow: 5L/min
Max. pressure: 7MPa
Speed range: 400-7000r/min
Rotation: R
Fuel feed hole: $\Phi 14.5$
Fuel discharge hole: M16 \times 1.5

Cross Ref.: 44320-02033,
44320-02032
Application: 98-00 Toyota Corolla



Drawing No.: **3407 0602 001**
Repair Kit.: **3407 0602 900**

Displacement: 6ml/r
Controlled flow: 6.3L/min
Max. pressure: 10MPa
Speed range: 500-8000r/min
Rotation: R
Fuel feed hole: $\Phi 16$
Fuel discharge hole: M16 \times 1.5

Cross Ref.: AVIA 490020,
44310-35610
Application: Toyota Innova
Toyota Hilux, Toyota Tacoma



SORL No.: **YBZ10D-080/085**
Drawing No.: **3407 1004 001**
Repair Kit.: **3407 1004 900**

Displacement: 10.5ml/r
Controlled flow: 8L/min
Max. pressure: 8.5MPa
Speed range: 500-7000r/min
Rotation: R
Fuel feed hole: $\Phi 16$
Fuel discharge hole: M16 \times 1.5

Cross Ref.: 25187887
Application: Toyota



SORL No.: **YBZ10D1-075/080**
 Drawing No.: **3407 1005 001**
 Repair Kit.: **3407 1005 900**

Displacement: 10.5ml/r
 Controlled flow: 7.5L/min
 Max. pressure: 8MPa
 Speed range: 500-7000r/min
 Rotation: R
 Fuel feed hole: $\Phi 14.5$
 Fuel discharge hole: M16 \times 1.5
 Cross Ref.: 44320-35221,
 44320-35361
 Application: 88-95 Toyota Pickup
 88-95 Toyota 4Runner 3.0Litres



SORL No.: **YBZ11-095/085**
 Drawing No.: **3407 1101 001**
 Repair Kit.: **3407 1101 900**

Displacement: 11ml/r
 Controlled flow: 8.5L/min
 Max. pressure: 8MPa
 Speed range: 500-8000r/min
 Rotation: R
 Fuel feed hole: $\Phi 16$
 Fuel discharge hole: M16 \times 1.5
 Cross Ref.: WP3400
 Application: Toyota Prado



SORL No.: **YBZ10F-095/080**
 Drawing No.: **3407 1006 001**
 Repair Kit.: **3407 1006 900**

Displacement: 10ml/r
 Controlled flow: 9.5L/min
 Max. pressure: 8MPa
 Speed range: 500-8000r/min
 Rotation: R
 Fuel feed hole: $\Phi 16$
 Fuel discharge hole: M16 \times 1.5
 Cross Ref.: 44310-12540,
 44310-02120, 44310-33150
 Application: Toyota



SORL No.: **YBZ11A-075/085**
 Drawing No.: **3407 1102 001**
 Repair Kit.: **3407 1102 900**

Displacement: 11ml/r
 Controlled flow: 7.5L/min
 Max. pressure: 8.5MPa
 Speed range: 500-8000r/min
 Rotation: R
 Fuel feed hole: $\Phi 16$
 Fuel discharge hole: M16 \times 1.5
 Cross Ref.: 44320-06010,
 44320-33060, 44320-33100,
 44320-06030, 44320-33071
 Application: Toyota



Drawing No.: **3407 1024 001**
 Repair Kit.: **3407 1024 900**

Displacement: 10ml/r
 Controlled flow: 6.9L/min
 Max. pressure: 8.8MPa
 Speed range: 400-7000r/min
 Rotation: R
 Fuel feed hole: $\Phi 14.5$
 Fuel discharge hole: M16 \times 1.5
 Application: 01-07 Toyota
 Highlander



SORL No.: **YBZ11D-090/085**
 Drawing No.: **3407 1104 001**
 Repair Kit.: **3407 1104 900**

Displacement: 11ml/r
 Controlled flow: 9L/min
 Max. pressure: 8.5MPa
 Speed range: 500-7000r/min
 Rotation: R
 Fuel feed hole: $\Phi 16$
 Fuel discharge hole: M16 \times 1.5
 Cross Ref.: 25187903,
 44320-60330, 44320-60191
 Application: Toyota



Drawing No.: **3407 1030 001**
 Repair Kit.: **3407 1030 900**

Displacement: 10ml/r
 Controlled flow: 7L/min
 Max. pressure: 8MPa
 Speed range: 500-7000r/min
 Rotation: R
 Fuel feed hole: $\Phi 16$
 Fuel discharge hole: M16 \times 1.5
 Application: Toyota Innova



SORL No.: **YBZ11M-070/100**
 Drawing No.: **3407 1107 001**
 Repair Kit.: **3407 1107 900**

Displacement: 11ml/r
 Controlled flow: 7L/min
 Max. pressure: 10MPa
 Speed range: 500-7000r/min
 Rotation: R
 Fuel feed hole: $\Phi 16$
 Fuel discharge hole: M16 \times 1.5
 Cross Ref.: 44320-35251
 Application: Toyota



Drawing No.: **3407 1045 001**
 Repair Kit.: **3407 1045 900**

Displacement: 10ml/r
 Controlled flow: 6.5L/min
 Max. pressure: 8MPa
 Speed range: 500-7000r/min
 Rotation: R
 Fuel feed hole: $\Phi 14.5$
 Fuel discharge hole: M16 \times 1.5
 Cross Ref.: 44320-04030
 Application: 95-98 Toyota T100
 95-04 Toyota Tacoma



SORL No.: **YBZ11M1-070/070**
 Drawing No.: **3407 1108 001**
 Repair Kit.: **3407 1108 900**

Displacement: 11ml/r
 Controlled flow: 7L/min
 Max. pressure: 7MPa
 Speed range: 500-7000r/min
 Rotation: R
 Fuel feed hole: $\Phi 16$
 Fuel discharge hole: M16 \times 1.5
 Application: Toyota



Displacement: 11ml/r
 Controlled flow: 7.6L/min
 Max. pressure: 7MPa
 Speed range: 400-7000r/min
 Rotation: R
 Fuel feed hole: $\Phi 18$
 Fuel discharge hole: M16 \times 1.5
 Cross Ref: 44320-02033
 948558906
 Application: 98-00Chevrolet Prizm
 98-00Toyota Corolla

Drawing No.: **3407 11165 001**
 Repair Kit.:



Displacement: 11ml/r
 Controlled flow: 8L/min
 Max. pressure: 8.5MPa
 Speed range: 400-7000r/min
 Rotation: R
 Fuel feed hole: $\Phi 14.5$
 Fuel discharge hole: M16 \times 1.5
 Cross Ref.: 44320-04052,
 44320-04051, 44320-04050,
 44320-35490
 Application: 96-02 Toyota 4Runner
 95-04 Toyota Tacoma

Drawing No.: **3407 1152 001**
 Repair Kit.: **3407 1152 900**



Displacement: 11ml/r
 Controlled flow: 7.6L/min
 Max. pressure: 8MPa
 Speed range: 400-7000r/min
 Rotation: R
 Fuel feed hole: $\Phi 12$
 Fuel discharge hole: M16 \times 1.5
 Cross Ref: 44320-60230
 44320-60260
 Application: 96-00 Toyota 4Runner
 97-01 Toyota Tacoma

Drawing No.: **3407 11172 001**
 Repair Kit.:



Displacement: 11ml/r
 Controlled flow: 8L/min
 Max. pressure: 9MPa
 Speed range: 400-7000r/min
 Rotation: R
 Fuel feed hole: $\Phi 14.5$
 Fuel discharge hole: M16 \times 1.5
 Cross Ref.: 44310-04120
 Application: 01-04 Toyota Tacoma

Drawing No.: **3407 1153 001**
 Repair Kit.: **3407 1153 900**



Displacement: 10.9ml/r
 Controlled flow: 10L/min
 Max. pressure: 9.7MPa
 Speed range: 400-7000r/min
 Rotation: R
 Fuel feed hole: $\Phi 14.5$
 Fuel discharge hole: M16 \times 1.5
 Cross Ref.: 44320-60181,
 44320-60182, 44320-60330,
 25187903
 Application: 96-97 Lexus LX450
 93-97 Toyota Landcruiser

Drawing No.: **3407 1129 001**
 Repair Kit.: **3407 1129 900**



Displacement: 11ml/r
 Controlled flow: 6L/min
 Max. pressure: 8.3MPa
 Speed range: 400-7000r/min
 Rotation: R
 Fuel feed hole: $\Phi 14.5$
 Fuel discharge hole: M16 \times 1.5
 Cross Ref.: 44310-08010,
 44310-06080
 Application: 01-06 Lexus ES330
 02-06 Toyota Camry

Drawing No.: **3407 1154 001**
 Repair Kit.: **3407 1154 900**



Displacement: 11ml/r
 Controlled flow: 5.8L/min
 Max. pressure: 8.5MPa
 Speed range: 400-7000r/min
 Rotation: R
 Fuel feed hole: $\Phi 14.5$
 Fuel discharge hole: M16 \times 1.5
 Cross Ref.: 44320-35480
 Application: 94-98 Toyota T100
 95-01 Toyota Tacoma

Drawing No.: **3407 1147 001**
 Repair Kit.: **3407 1147 900**



Displacement: 10.5ml/r
 Controlled flow: 6.8L/min
 Max. pressure: 7.6MPa
 Speed range: 400-7000r/min
 Rotation: R
 Fuel feed hole: $\Phi 14.5$
 Fuel discharge hole: M16 \times 1.5
 Cross Ref.: 44320-14161,
 44320-35120, 44320-35140,
 44320-35210, 44320-35240
 44320-35241, 44320-35310,
 44320-35340
 Application: 89-95 Toyota 4Runner
 89-95 Toyota Pickup

Drawing No.: **3407 1157 001**
 Repair Kit.: **3407 1157 900**



Displacement: 11ml/r
 Controlled flow: 7.9L/min
 Max. pressure: 8.5MPa
 Speed range: 400-7000r/min
 Rotation: R
 Fuel feed hole: $\Phi 14.5$
 Fuel discharge hole: M16 \times 1.5
 Cross Ref.: 44320-60230,
 44320-60260
 Application: 96-00 Toyota 4Runner
 97-01 Toyota Tacoma

Drawing No.: **3407 1149 001**
 Repair Kit.: **3407 1149 900**



Displacement: 13ml/r
 Controlled flow: 9L/min
 Max. pressure: 8.5MPa
 Speed range: 500-8000r/min
 Rotation: R
 Fuel feed hole: $\Phi 14.5$
 Fuel discharge hole: M16 \times 1.5
 Cross Ref.: 44310-0C030
 Application: 01-07 Toyota Sequoia
 00-06 Toyota Tundra

Drawing No.: **3407 1313 001**
 Repair Kit.: **3407 1313 900**

Pictures And/Or OEM Part Numbers are for reference purpose only.



Displacement: 13ml/r
Controlled flow: 8L/min
Max. pressure: 8.5MPa
Speed range: 500-8000r/min
Rotation: R
Fuel feed hole: $\Phi 14.5$
Fuel discharge hole: M16 \times 1.5

Cross Ref.: 44320-35610
Application: 03-09 Lexus GX470
03-09 Toyota 4 Runner

Drawing No.: **3407 1314 001**
Repair Kit.: **3407 1314 900**



Displacement: 14ml/r
Controlled flow: 9L/min
Max. pressure: 8MPa
Speed range: 500-3600r/min
Rotation: R
Fuel feed hole: $\Phi 22$
Fuel discharge hole: M16 \times 1.5

SORL No.: **YBZ14-090/080**
Drawing No.: **3407 1402 001**
Repair Kit.: **3407 1402 900**

Cross Ref.: 25187888
Application: Toyota SUV



Displacement: 13ml/r
Controlled flow: 8L/min
Max. pressure: 7MPa
Speed range: 500-8000r/min
Rotation: R
Fuel feed hole: $\Phi 14.5$
Fuel discharge hole: M16 \times 1.5'

Cross Ref.: 44320-53030
Application: 98-05 Toyota Lexus IS300

Drawing No.: **3407 1316 001**
Repair Kit.: **3407 1316 900**



Displacement: 15ml/r
Controlled flow: 8L/min
Max. pressure: 8MPa
Speed range: 500-7000r/min
Rotation: R
Fuel feed hole: $\Phi 19.4$
Fuel discharge hole: M16 \times 1.5

SORL No.: **YBZ15C-080/080**
Drawing No.: **3407 1506 001**
Repair Kit.: **3407 1506 900**

Cross Ref.: PSP 531
Application: Toyota



Displacement: 13ml/r
Controlled flow: 9L/min
Max. pressure: 8.5MPa
Speed range: 500-8000r/min
Rotation: R
Fuel feed hole: $\Phi 14.5$
Fuel discharge hole: M16 \times 1.5

Cross Ref.: 44310-0C010
Application: 00-04 Toyota Tundra

Drawing No.: **3407 1318 001**
Repair Kit.: **3407 1318 900**



Displacement: 13.6ml/r
Controlled flow: 9L/min
Max. pressure: 10MPa
Speed range: 500~3600r/min
Rotation: R
Fuel feed hole: $\Phi 22$
Fuel discharge hole: M16 \times 1.5

Cross Ref: 44320-87304,
44310-37070,44320-36250
Application: TOYOTA 14B

SORL No.: **3407 14182 001**



Displacement: 13ml/r
Controlled flow: 10.6L/min
Max. pressure: 9MPa
Speed range: 400-7000r/min
Rotation: R
Fuel feed hole: $\Phi 12$
Fuel discharge hole: M16 \times 1.5

Cross Ref: 44310-0C010
Application: 2000-2004 Toyota Trucks Tundra

Drawing No.: **3407 1333 001**
Repair Kit.:



Displacement: 21ml/r
Controlled flow: 16L/min
Max. pressure: 12MPa
Speed range: 500~3600r/min
Rotation: L
Fuel feed hole: $\Phi 20$
Fuel discharge hole: M16 \times 1.5

Cross Ref: 44310-EW021,
AG:P00218G
Application: HINO 500

SORL No.: **3407 21221 001**



Displacement: 14ml/r
Controlled flow: 6.5L/min
Max. pressure: 8MPa
Speed range: 500-3600r/min
Rotation: R
Fuel feed hole: $\Phi 22$
Fuel discharge hole: M16 \times 1.5

Cross Ref.: 25187888,
44320-36240, 44320-60220,
44320-60171
Application: Toyota SUV

SORL No.: **YBZ14-065/080**
Drawing No.: **3407 1401 001**
Repair Kit.: **3407 1401 900**



Displacement: 8.2ml/r
Controlled flow: 6.8L/min
Max. pressure: 8.5MPa
Speed range: 500~6000r/min
Rotation: R
Fuel feed hole: $\Phi 16$
Fuel discharge hole: M16 \times 1.5

Cross Ref: 5590,44310-17060,
44310-28240,44310-48030,
Application: 2007-2001Toyota Trucks Highlander 4 Cyl.

SORL No.: **3407 10110 001**



SORL No.: **3407 06128 001**

Displacement: 8.2ml/r
 Controlled flow: 7.2L/min
 Max.pressure: 10.5MPa
 Speed range: 400~7000r/min
 Rotation: R
 Fuel feed hole: Φ 14.5
 Fuel discharge hole: M16 \times 1.5
 Cross Ref: 96-5343,4743801AC,
 AF,AG
 Application: CHRY TRK
 PACIFICA 3.5L V6 06-04
 Family Type: Toyota – 8



SORL No.: **3407 11205 001**

Displacement: 13.3ml/r
 Controlled flow: 11.4L/min
 Max.pressure: 9.2MPa
 Speed range: 500~6000r/min
 Rotation: R
 Fuel feed hole: Φ 16
 Fuel discharge hole: M16 \times 1.5
 Cross Ref: 5385,21-5879,
 44320-60182
 Application: 97-96 Lexus Trucks LX450,
 97-93 Toyota Trucks Landcruiser



SORL No.: **3407 08134 001**

Displacement: 8.5ml/r
 Controlled flow: 6L/min
 Max.pressure: 7.4MPa
 Speed range: 400~7000r/min
 Rotation: R
 Fuel feed hole: Φ 14.5
 Fuel discharge hole: M16 \times 1.5
 Cross Ref: 96-5945,44320-42011
 44320-42012,44320-42060
 Application: TOYOTA RAV4 2.0L L4
 (1997-2000),ELECTRIC(1998-2000)



SORL No.: **3407 11174 001**

Displacement: 11.7ml/r
 Controlled flow: 8.3L/min
 Max.pressure: 9MPa
 Speed range: 500~6000r/min
 Rotation: R
 Fuel feed hole: Φ 16
 Fuel discharge hole: M16 \times 1.5
 Cross Ref: 5778,21-5287,5630,
 44310-06080
 Application: 03-01 Lexus ES300,
 06-04 Lexus ES330,
 06-03 Toyota Camry 6 Cyl.



SORL No.: **3407 11205 001**

Displacement: 11ml/r
 Controlled flow: 5.7L/min
 Max.pressure: 8.5MPa
 Speed range: 400~7000r/min
 Rotation: R
 Fuel feed hole: Φ 14.5
 Fuel discharge hole: M16 \times 1.5
 Cross Ref: 96-5876,44320-06030,
 44320-33060,44320-33071
 Application: TOYOTA ,CAMRY,
 SOLARA 01-92



SORL No.: **3407 11177 001**

Displacement: 10.9ml/r
 Controlled flow: 7.6L/min
 Max.pressure: 8MPa
 Speed range: 500~6000r/min
 Rotation: R
 Fuel feed hole: Φ 10
 Fuel discharge hole: M16 \times 1.5
 Cross Ref: 50100,44302-04030
 Application: 02-01 Toyota Trucks 4Runner,
 00-96 Toyota Trucks 4Runner,
 04-98 Toyota Trucks Tacoma 6 Cyl.



SORL No.: **3407 11166 001**

Displacement: 10.9ml/r
 Controlled flow: 7.6L/min
 Max.pressure: 9MPa
 Speed range: 500~6000r/min
 Rotation: R
 Fuel feed hole: Φ 10
 Fuel discharge hole: M16 \times 1.5
 Cross Ref: 5779,44310-04120,
 21-5248,AA121-5248
 Application: 02-96 Toyota Trucks 4Runner,
 04-98 Toyota Trucks Tacoma



SORL No.: **3407 1332 001**

Displacement: 13ml/r
 Controlled flow: 8.5L/min
 Max.pressure: 9MPa
 Speed range: 400~7000r/min
 Rotation: R
 Fuel feed hole: Φ 16
 Fuel discharge hole: M16 \times 1.5
 Cross Ref: 5632,21-5371,
 44320-35610
 Application: 2009-2003Lexus Trucks GX470
 2009-2003Toyota Trucks 4Runner 4.7 Liters



SORL No.: **3407 11173 001**

Displacement: 13.3ml/r
 Controlled flow: 11.4L/min
 Max.pressure: 9.2MPa
 Speed range: 500~6000r/min
 Rotation: R
 Fuel feed hole: Φ 16
 Fuel discharge hole: M16 \times 1.5
 Cross Ref: 5385,21-5879,44320-60182
 Application: 97-96 Lexus Trucks LX450,
 97-93 Toyota Trucks Landcruiser



DAEWOO



Displacement: 13ml/r
Controlled flow: 12L/min
Max. pressure: 12.5MPa
Speed range: 500-3500r/min
Rotation: R
Fuel feed hole: Φ 20
Fuel discharge hole: 3/4-16UNF

SORL No.: **YBZ20F5-120/125**
Drawing No.: **3407 1304 001**
Repair Kit.: **3407 1304 900**

Cross Ref.: 1401-2015A, S-303
Application:
Daewoo FD3.5t FORK LIFTER



Displacement: 20ml/r
Controlled flow: 22.5L/min
Max. pressure: 14MPa
Speed range: 500-3200r/min
Rotation: R
Fuel feed hole: NPT11/4
Fuel discharge hole: 3/4-16UNF

SORL No.: **YBZ20C3-225/140**
Drawing No.: **3407 2007 001**
Repair Kit.: **3407 2007 900**

Cross Ref.: V20F1P6P38C6H11
Application: Daewoo



Displacement: 20ml/r
Controlled flow: 18L/min
Max. pressure: 8MPa
Speed range: 500-3200r/min
Rotation: R
Fuel feed hole: RC3/4
Fuel discharge hole: RC1/2

SORL No.: **YBZ20C2-180/080**
Drawing No.: **3407 2003 001**
Repair Kit.: **3407 2003 900**

Cross Ref.: V10-YOUNG
Application:



Displacement: 20ml/r
Controlled flow: 18L/min
Max. pressure: 12.5MPa
Speed range: 500-3500r/min
Rotation: R
Fuel feed hole: M26 \times 1.5
Fuel discharge hole: M18 \times 1.5

SORL No.: **YBZ20F3-180/125**
Drawing No.: **3407 2019 001**
Repair Kit.: **3407 2019 900**

Cross Ref.: 65.47101-7017,
S-104
Application: Daewoo1146, 28 8~15t



Displacement: 20ml/r
Controlled flow: 20.5L/min
Max. pressure: 8MPa
Speed range: 500-3200r/min
Rotation: R
Fuel feed hole: RC3/4
Fuel discharge hole: RC1/2

SORL No.: **YBZ20C2-205/080**
Drawing No.: **3407 2004 001**
Repair Kit.: **3407 2004 900**

Cross Ref.: V10
Application: Daewoo



Displacement: 20ml/r
Controlled flow: 18L/min
Max. pressure: 12.5MPa
Speed range: 500-3500r/min
Rotation: R
Fuel feed hole: M26 \times 1.5
Fuel discharge hole: M18 \times 1.5
Cross Ref.: 65.47101-7022,
S-204
Application: Daewoo 8~15t Bus,
Truck, Double Turbo Engine

SORL No.: **YBZ20F3A-180/125**
Drawing No.: **3407 2020 001**
Repair Kit.: **3407 2020 900**



Displacement: 20ml/r
Controlled flow: 20.5L/min
Max. pressure: 8MPa
Speed range: 500-3200r/min
Rotation: R
Fuel feed hole: RC3/4
Fuel discharge hole: RC1/2

SORL No.: **YBZ20C2A-205/080**
Drawing No.: **3407 2005 001**
Repair Kit.: **3407 2005 900**

Cross Ref.: V10-SA
Application: Daewoo



Displacement: 20ml/r
Controlled flow: 18L/min
Max. pressure: 12.5MPa
Speed range: 500-3500r/min
Rotation: R
Fuel feed hole: M26 \times 1.5
Fuel discharge hole: M18 \times 1.5

SORL No.: **YBZ20F4-180/125**
Drawing No.: **3407 2022 001**
Repair Kit.: **3407 2022 900**

Cross Ref.: 65.47101-7029
65.47101-6040, B3
Application: Daewoo Engine DE12



Displacement: 20ml/r
Controlled flow: 20.5L/min
Max. pressure: 8MPa
Speed range: 500-3200r/min
Rotation: R
Fuel feed hole: RC3/4
Fuel discharge hole: RC1/2

SORL No.: **YBZ20C2B-205/080**
Drawing No.: **3407 2006 001**
Repair Kit.: **3407 2006 900**

Cross Ref.: V10-DAE
Application: Daewoo



Displacement: 20ml/r
Controlled flow: 16L/min
Max. pressure: 15MPa
Speed range: 500-3500r/min
Rotation: R
Fuel feed hole: M26 \times 1.5
Fuel discharge hole: M18 \times 1.5

SORL No.: **YBZ20F4A-160/150**
Drawing No.: **3407 2023 001**
Repair Kit.: **3407 2023 900**

Cross Ref.: 65.47101-2046
65.47101-6040
Application: Daewoo

Pictures And/Or OEM Part Numbers are for reference purpose only.



Displacement: 20ml/r
 Controlled flow: 16L/min
 Max. pressure: 12.5MPa
 Speed range: 500-3500r/min
 Rotation: R
 Fuel feed hole: M26×1.5
 Fuel discharge hole: M18×1.5

SORL No.: **YBZ20F3-160/125**
 Drawing No.: **3407 2030 001**
 Repair Kit.: **3407 2030 900**

Cross Ref.: 65.47101-7025
 Application: Daewoo 106, 113,
 120 Bus



Displacement: 21ml/r
 Controlled flow: 19L/min
 Max. pressure: 12.5MPa
 Speed range: 500-4500r/min
 Rotation: L
 Fuel feed hole: M26×1.5
 Fuel discharge hole: M18×1.5

SORL No.: **YBZ20B-190/125L**
 Drawing No.: **3407 2113 001**
 Repair Kit.: **3407 2113 900**

Cross Ref.: 34333-00300,
 7685 955 776
 Application: Daewoo



Displacement: 20ml/r
 Controlled flow: 16L/min
 Max. pressure: 10MPa
 Speed range: 500-3500r/min
 Rotation: R
 Fuel feed hole: M26×1.5
 Fuel discharge hole: M18×1.5

SORL No.: **YBZ20F3-160/100**
 Drawing No.: **3407 2037 001**
 Repair Kit.: **3407 2037 900**

Cross Ref.: 65.47101-7019
 Application: Daewoo Areo Bus,
 Truck



Displacement: 21ml/r
 Controlled flow: 19L/min
 Max. pressure: 14MPa
 Speed range: 500-4500r/min
 Rotation: L
 Fuel feed hole: M26×1.5
 Fuel discharge hole: M18×1.5

SORL No.: **YBZ20B-190/140L**
 Drawing No.: **3407 2193 001**
 Repair Kit.: **3407 2193 900**

Cross Ref.: 34333 00480,
 C4333 00010
 Application: Daewoo



Displacement: 20ml/r
 Controlled flow: 16L/min
 Max. pressure: 12.5MPa
 Speed range: 500-3500r/min
 Rotation: R
 Fuel feed hole: M26×1.5
 Fuel discharge hole: M18×1.5

SORL No.: **YBZ20F4-160/125**
 Drawing No.: **3407 2038 001**
 Repair Kit.: **3407 2038 900**

Cross Ref.: 65.47101-6041,
 65.47101-6040
 Application: Daewoo Engine 2366



Displacement: 21ml/r
 Controlled flow: 20L/min
 Max. pressure: 12.5MPa
 Speed range: 500-4500r/min
 Rotation: L
 Fuel feed hole: M26×1.5
 Fuel discharge hole: M18×1.5

SORL No.: **YBZ20D2A-200/125L**
 Drawing No.: **3407 2194 001**
 Repair Kit.: **3407 2194 900**

Cross Ref.: 34333 00520
 Application: Daewoo



Displacement: 20ml/r
 Controlled flow: 16L/min
 Max. pressure: 10MPa
 Speed range: 500-3500r/min
 Rotation: R
 Fuel feed hole: M26×1.5
 Fuel discharge hole: M18×1.5

SORL No.: **YBZ20F4-160/100**
 Drawing No.: **3407 2039 001**
 Repair Kit.: **3407 2039 900**

Cross Ref.: 65.47101-6042,
 65.47101-6040
 Application: Daewoo



Displacement: 21ml/r
 Controlled flow: 18L/min
 Max. pressure: 13MPa
 Speed range: 500-4500r/min
 Rotation: L
 Fuel feed hole: M26×1.5
 Fuel discharge hole: M18×1.5

SORL No.: **YBZ20D2A-180/130L**
 Drawing No.: **3407 2195 001**
 Repair Kit.: **3407 2195 900**

Cross Ref.: 34333 00600
 Application: Daewoo



Displacement: 21ml/r
 Controlled flow: 19L/min
 Max. pressure: 12.5MPa
 Speed range: 500-4500r/min
 Rotation: R
 Fuel feed hole: M26×1.5
 Fuel discharge hole: M18×1.5

SORL No.: **YBZ20B-190/125**
 Drawing No.: **3407 2112 001**
 Repair Kit.: **3407 2112 900**

Cross Ref.: 34333-00410,
 7685 955 804
 Application: Daewoo



Displacement: 30ml/r
 Controlled flow: 25L/min
 Max. pressure: 16.5MPa
 Speed range: 500-3600r/min
 Rotation: L
 Fuel feed hole: M26×1.5
 Fuel discharge hole: M18×1.5

SORL No.: **YBZ30-250/165L**
 Drawing No.: **3407 3001 001**
 Repair Kit.: **3407 3001 900**

Application: Daewoo

Pictures And/Or OEM Part Numbers are for reference purpose only.



Displacement: 30ml/r
Controlled flow: 23L/min
Max. pressure: 16.5MPa
Speed range: 500-3600r/min
Rotation: L
Fuel feed hole: M26×1.5
Fuel discharge hole: M18×1.5

SORL No.: **YBZ30A-230/165L**
Drawing No.: **3407 3002 001**
Repair Kit.: **3407 3002 900**

Application: Daewoo



Displacement: 34ml/r
Controlled flow: 26L/min
Max. pressure: 12.5MPa
Speed range: 500-3700r/min
Rotation: R
Fuel feed hole: M33×2
Fuel discharge hole: M22×1.5

SORL No.: **YBZ34A1-260/125**
Drawing No.: **3407 3402 001**
Repair Kit.: **3407 3402 900**

Cross Ref.: 57100-75550, Y1800S
Application: Daewoo



Displacement: 30ml/r
Controlled flow: 25L/min
Max. pressure: 18MPa
Speed range: 500-2700r/min
Rotation: L
Fuel feed hole: M26×1.5
Fuel discharge hole: M18×1.5

SORL No.: **YBZ30B-250/165L**
Drawing No.: **3407 3003 001**
Repair Kit.: **3407 3003 900**

Cross Ref.: 34333-00500
Application: Daewoo



Displacement: 34ml/r
Controlled flow: 26L/min
Max. pressure: 12.5MPa
Speed range: 500~3600r/min
Rotation: R
Fuel feed hole: M33×1.5
Fuel discharge hole: M22×1.5

SORL No.: **3407 3415 001**

Cross Ref: 57100-75550 Y1800S
with gear
Application: DAEWOO



Displacement: 32ml/r
Controlled flow: 25L/min
Max. pressure: 16.5MPa
Speed range: 500-2700r/min
Rotation: L
Fuel feed hole: M26×1.5
Fuel discharge hole: M18×1.5

SORL No.: **YBZ32-250/165L**
Drawing No.: **3407 3201 001**
Repair Kit.: **3407 3201 900**

Cross Ref.: 34333-00370,
7688 955 513
Application: Daewoo



Displacement: 34ml/r
Controlled flow: 25L/min
Max. pressure: 13.5MPa
Speed range: 500~3600r/min
Rotation: R
Fuel feed hole: M33×1.5
Fuel discharge hole: M22×1.5

SORL No.: **3407 3416 001**

Cross Ref: Y1800S
Application: HYUNDAI 18t
SUPER TRUCK



Displacement: 32ml/r
Controlled flow: 25L/min
Max. pressure: 16.5MPa
Speed range: 500-2700r/min
Rotation: L
Fuel feed hole: M26×1.5
Fuel discharge hole: M18×1.5

SORL No.: **YBZ32A-250/165L**
Drawing No.: **3407 3202 001**
Repair Kit.: **3407 3202 900**

Cross Ref.: 34333-00370,
7688 955 508
Application: Daewoo



Displacement: 34ml/r
Controlled flow: 20L/min
Max. pressure: 13.5MPa
Speed range: 500~3600r/min
Rotation: R
Fuel feed hole: M33×1.5
Fuel discharge hole: M22×1.5

SORL No.: **3407 3417 001**

Cross Ref: Y1800T
Application: HYUNDAI 18t
SUPER TRUCK



Displacement: 34ml/r
Controlled flow: 28L/min
Max. pressure: 12.5MPa
Speed range: 500-3700r/min
Rotation: R
Fuel feed hole: M33×2
Fuel discharge hole: M22×1.5

SORL No.: **YBZ34A-280/125**
Drawing No.: **3407 3401 001**
Repair Kit.: **3407 3401 900**

Cross Ref.: 57100-75550, Y1800T
Application: Daewoo



HYUNDAI



Displacement: 7ml/r
Controlled flow: 5.6L/min
Max. pressure: 6MPa
Speed range: 500-7000r/min
Rotation: R
Fuel feed hole: $\Phi 15$
Fuel discharge hole: M16 \times 1.5

Drawing No.: **3407 0716 001**
Repair Kit.: **3407 0716 900**

Cross Ref.: 57100 02710
Application: Hyundai Santro



Displacement: 8ml/r
Controlled flow: 7.6L/min
Max. pressure: 8.5MPa
Speed range: 500-7000r/min
Rotation: R
Fuel feed hole: $\Phi 16$
Fuel discharge hole: M16 \times 1.5

SORL No.: **YBZ08L1-076/085**
Drawing No.: **3407 0813 001**
Repair Kit.: **3407 0813 900**

Cross Ref.: 57100 26300/A,
7078 955 617
Application: Santafe1.8T



Displacement: 7ml/r
Controlled flow: 5.6L/min
Max. pressure: 6MPa
Speed range: 500-8000r/min
Rotation: R
Fuel feed hole: $\Phi 15$
Fuel discharge hole: M16 \times 1.5

Drawing No.: **3407 0724 001**
Repair Kit.: **3407 0724 900**

Application: Hyundai



Displacement: 10ml/r
Controlled flow: 8L/min
Max. pressure: 7.5MPa
Speed range: 500-7000r/min
Rotation: R
Fuel feed hole: $\Phi 15$
Fuel discharge hole: M16 \times 1.5
Cross Ref.: 57100 26100,
57100 38500, 57100 2G100
Application: Hyundai Santa,
Santafe 2.7

SORL No.: **YBZ10C-080/075**
Drawing No.: **3407 1003 001**
Repair Kit.: **3407 1003 900**



Displacement: 7.4ml/r
Controlled flow: 7.5L/min
Max. pressure: 9.5MPa
Speed range: 500-7000r/min
Rotation: R
Fuel feed hole: $\Phi 17.2$
Fuel discharge hole: M12 \times 1.25-6g

Drawing No.: **3407 0747 001**
Repair Kit.: **3407 0747 900**

Cross Ref: 3P078
28293676
YOUNG SHIN:IYS0113



Displacement: 9.6ml/r
Controlled flow: 7L/min
Max. pressure: 8.5MPa
Speed range: 400-7000r/min
Rotation: R
Fuel feed hole: $\Phi 16.7$
Fuel discharge hole: M16 \times 1.5

Drawing No.: **3407 10100 001**
Repair Kit.: **3407 10100 900**

Cross Ref: 57100-2B300
57100-2B301
Application: SANTAFE 2.7 V6 GLS



Displacement: 7.4ml/r
Controlled flow: 5.6L/min
Max. pressure: 8MPa
Speed range: 500-7000r/min
Rotation: R
Fuel feed hole: $\Phi 17.7$
Fuel discharge hole: M14 \times 1.5

Drawing No.: **3407 0748 001**
Repair Kit.: **3407 0748 900**

Cross Ref: G060-7700A
TAF9204
YOUNG SHIN:IYS0G24



Displacement: 10ml/r
Controlled flow: 6.5L/min
Max. pressure: 8MPa
Speed range: 500-7000r/min
Rotation: R
Fuel feed hole: $\Phi 12$
Fuel discharge hole: M16 \times 1.5

SORL No.: **YBZ10T-065/080**
Drawing No.: **3407 1014 001**
Repair Kit.: **3407 1014 900**

Cross Ref.: 57110 H1300
Application: Terracan3.5



Displacement: 8ml/r
Controlled flow: 8.3L/min
Max. pressure: 7.8MPa
Speed range: 500-7000r/min
Rotation: R
Fuel feed hole: $\Phi 15$
Fuel discharge hole: M16 \times 1.5

SORL No.: **YBZ08K-083/078**
Drawing No.: **3407 0811 001**
Repair Kit.: **3407 0811 900**

Cross Ref.: 57100 26300
Application: Santafe2.0



Displacement: 10ml/r
Controlled flow: 6.5L/min
Max. pressure: 8MPa
Speed range: 500-7000r/min
Rotation: R
Fuel feed hole: $\Phi 12$
Fuel discharge hole: M16 \times 1.5

SORL No.: **YBZ10T1-065/080**
Drawing No.: **3407 1015 001**
Repair Kit.: **3407 1015 900**

Cross Ref.: 57110H1000
Application: Terracan 2.5

Pictures And/Or OEM Part Numbers are for reference purpose only.



Displacement: 9.6ml/r
Controlled flow: 9L/min
Max. pressure: 9.5MPa
Speed range: 400-7000r/min
Rotation: R
Fuel feed hole: $\Phi 15$
Fuel discharge hole: M16 \times 1.5

Cross Ref: 57100-4F250
YOUNG SHIN(YSM10C)
Application: Hyundai HR2013

Drawing No.: **3407 1096 001**
Repair Kit: **3407 1096 001**



Displacement: 34ml/r
Controlled flow: 26L/min
Max. pressure: 12.5MPa
Speed range: 500-3700r/min
Rotation: R
Fuel feed hole: M33 \times 2
Fuel discharge hole: M22 \times 1.5

Cross Ref.: 57100-75550, Y1800S
Application: Hyundai 18t Super Truck

SORL No.: **YBZ34A1-260/125**
Drawing No.: **3407 3402 001**
Repair Kit: **3407 3402 900**



Displacement: 14ml/r
Controlled flow: 12L/min
Max. pressure: 10.5MPa
Speed range: 500-3500r/min
Rotation: R
Fuel feed hole: $\Phi 18$
Fuel discharge hole: M16 \times 1.5

Cross Ref.: 57100-6A800
Application: Hyundai

SORL No.: **YBZ14F-120/105**
Drawing No.: **3407 1412 001**
Repair Kit: **3407 1412 900**



Displacement: 9.6ml/r
Controlled flow: 7L/min
Max. pressure: 8.5MPa
Speed range: 500~7000r/min
Rotation: R
Fuel feed hole: $\Phi 15$
Fuel discharge hole: M16 \times 1.5

Cross Ref: 46-296
Application: SANTAFE 2.7 V6 GLS

SORL No.: **3407 10100 001**



Displacement: 20ml/r
Controlled flow: 17L/min
Max. pressure: 10.5MPa
Speed range: 500-3700r/min
Rotation: R
Fuel feed hole: $\Phi 23$
Fuel discharge hole: 3/4-16UNF

Cross Ref.: 57100-86152,
S-103
Application: Hyundai

SORL No.: **YBZ20F-120/105**
Drawing No.: **3407 2011 001**
Repair Kit: **3407 2011 900**



Displacement: 9.6ml/r
Controlled flow: 9.1L/min
Max. pressure: 9MPa
Speed range: 500~6000r/min
Rotation: R
Fuel feed hole: $\Phi 15$
Fuel discharge hole: M16 \times 1.5
Cross Ref: 5837,57100-2E100
Application: 2009-2005Hyundai Trucks
Tucson 2.7 Liters,
2010-2005Kia Trucks Sportage 6 Cyl.

SORL No.: **3407 10108 001**



Displacement: 21ml/r
Controlled flow: 17L/min
Max. pressure: 12.5MPa
Speed range: 500-3500r/min
Rotation: R
Fuel feed hole: $\Phi 23$
Fuel discharge hole: 3/4-16UNF
Cross Ref.: 57100-73102,
57100-73112,
57100-76000, S-103
Application: Hyundai 11t Truck

SORL No.: **YBZ20F-120/105**
Drawing No.: **3407 2012 001**
Repair Kit: **3407 2012 900**



Displacement: 10ml/r
Controlled flow: 8.5L/min
Max. pressure: 7MPa
Speed range: 500~6000r/min
Rotation: R
Fuel feed hole: $\Phi 12$
Fuel discharge hole: M12 \times 1.25

Cross Ref: EA1808
Application:

SORL No.: **3407 10160 001**



Displacement: 34ml/r
Controlled flow: 28L/min
Max. pressure: 12.5MPa
Speed range: 500-3700r/min
Rotation: R
Fuel feed hole: M33 \times 2
Fuel discharge hole: M22 \times 1.5

Cross Ref.: 57100-75550, Y1800T
Application: Hyundai 18t Super Truck

SORL No.: **YBZ34A-280/125**
Drawing No.: **3407 3401 001**
Repair Kit: **3407 3401 900**



Displacement: 14ml/r
Controlled flow: 12L/min
Max. pressure: 10.5MPa
Speed range: 500~3600r/min
Rotation: R
Fuel feed hole: $\Phi 18$
Fuel discharge hole: M16 \times 1.5

Cross Ref: 57100-6A800
Application: HYUNDAI

SORL No.: **3407 14211 001**



Displacement: 24.3ml/r
Controlled flow: 24L/min
Max. pressure: 0MPa
Speed range: 500~3600r/min
Rotation: R
Fuel feed hole: M26×1.5
Fuel discharge hole: 3/4-16UNF

SORL No.: **3407 2408 001**

Cross Ref: 7686 955 746
Application: Hyundai



Displacement: 28ml/r
Controlled flow: 23L/min
Max. pressure: 13MPa
Speed range: 500-3500r/min
Rotation: R
Fuel feed hole: Φ16
Fuel discharge hole: M16×1.5

SORL No.: **YBZ28F-230/130**
Drawing No.: **3407 2801 001**
Repair Kit.: **3407 2801 900**

Cross Ref.: AA61K-13710
Application: KIA Cargo 16~18t



Displacement: 10ml/r
Controlled flow: 8L/min
Max. pressure: 7.5MPa
Speed range: 500-7000r/min
Rotation: R
Fuel feed hole: Φ15
Fuel discharge hole: M16×1.5

SORL No.: **YBZ10C-080/075**
Drawing No.: **3407 1003 001**
Repair Kit.: **3407 1003 900**

Cross Ref.: 5710026100,
5710038500, 571002G100
Application: KIA Optima



Displacement: 17ml/r
Controlled flow: 16L/min
Max. pressure: 14MPa
Speed range: 500-4000r/min
Rotation: R
Fuel feed hole: M26×1.5
Fuel discharge hole: M16×1.5

Drawing No.: **3407 1702 001**
Repair Kit.: **3407 1702 900**

Cross Ref.: 303-02-0058,
7673 955 573
Application: AMW



Displacement: 20ml/r
Controlled flow: 20L/min
Max. pressure: 13MPa
Speed range: 500-3500r/min
Rotation: R
Fuel feed hole: Φ12
Fuel discharge hole: M16×1.5

SORL No.: **YBZ20F2-200/130**
Drawing No.: **3407 2017 001**
Repair Kit.: **3407 2017 900**

Cross Ref.: AA61D-13710,
44300-1641
Application: KIA 8.5~15t Truck Bus



Displacement: 17ml/r
Controlled flow: 16L/min
Max. pressure: 15MPa(Without)
Speed range: 500-4000r/min
Rotation: R
Fuel feed hole: M26×1.5
Fuel discharge hole: M16×1.5

Drawing No.: **3407 1749 001**
Repair Kit.: **3407 1749 900**

Cross Ref.: 303-02-0059,
7673 955 800
Application: AMW



Displacement: 20ml/r
Controlled flow: 17L/min
Max. pressure: 13MPa
Speed range: 500-3500r/min
Rotation: R
Fuel feed hole: Φ12
Fuel discharge hole: M16×1.5

SORL No.: **YBZ25F-170/130**
Drawing No.: **3407 2501 001**
Repair Kit.: **3407 2501 900**

Cross Ref.: AA92A-13710, EF-750
Application: KIA B.H.D Bus



ASHOK LEYLAND



Displacement: 15ml/r
 Controlled flow: 10L/min
 Max. pressure: 10MPa
 Speed range: 500-3600r/min
 Rotation: L
 Fuel feed hole: M26×1.5
 Fuel discharge hole: M16×1.5

Drawing No.: **3407 1534 001**
 Repair Kit.: **3407 1534 900**

Cross Ref.: 832 0900, 30210036
 Application: Ashok Leyland



Displacement: 17ml/r
 Controlled flow: 14L/min
 Max. pressure: 11MPa
 Speed range: 500-3600r/min
 Rotation: L
 Fuel feed hole: M26×1.5
 Fuel discharge hole: M18×1.5

Drawing No.: **3407 1735 001**
 Repair Kit.: **3407 1735 900**

Cross Ref.: 7673 955 304
 Application: Ashok Leyland



Displacement: 13.9ml/r
 Controlled flow: 9L/min
 Max. pressure: 13MPa
 Speed range: 500-4000r/min
 Rotation: R
 Fuel feed hole: M26×1.5
 Fuel discharge hole: M16×1.5

Drawing No.: **3407 1436 001**
 Repair Kit.: **3407 1436 900**

Cross Ref.: IA307875, 7672 955 817
 Application: Eicher



Displacement: 17ml/r
 Controlled flow: 16L/min
 Max. pressure: 15MPa(without)
 Speed range: 500-3500r/min
 Rotation: L
 Fuel feed hole: M26×1.5
 Fuel discharge hole: M18×1.5

Drawing No.: **3407 1747 001**
 Repair Kit.: **3407 1747 900**

Cross Ref.: 7673 955 802
 Application: Ashok Leyland



Displacement: 16.6ml/r
 Controlled flow: 16L/min
 Max. pressure: 13.5MPa
 Speed range: 500-4500r/min
 Rotation: L
 Fuel feed hole: M26×1.5
 Fuel discharge hole: M18×1.5

Drawing No.: **3407 1540 001**
 Repair Kit.: **3407 1540 900**

Cross Ref.: 7673 955 804,
 7673 955 303
 Application: Eicher



Displacement: 16.6ml/r
 Controlled flow: 11.5L/min
 Max. pressure: 12MPa
 Speed range: 600-3600r/min
 Rotation: R
 Fuel feed hole: M26×1.5
 Fuel discharge hole: M16×1.5

Drawing No.: **3407 1756 001**
 Repair Kit.: **3407 1756 900**

Cross Ref.: 8809210
 Application: Ashok Leyland



Displacement: 17.5ml/r
 Controlled flow: 16L/min
 Max. pressure: 15MPa(Without)
 Speed range: 500-3700r/min
 Rotation: L
 Fuel feed hole: M26×1.5
 Fuel discharge hole: M18×1.5

Drawing No.: **3407 1753 001**
 Repair Kit.: **3407 1753 900**

Application: Eicher



Displacement: 17ml/r
 Controlled flow: 15L/min
 Max. pressure:
 15MPa(Without)
 Speed range: 600-3600r/min
 Rotation: R
 Fuel feed hole: M26×1.5
 Fuel discharge hole: M16×1.5
 Cross Ref.: FC900412,
 7673 955 807/1
 Application: Ashok Leyland

Drawing No.: **3407 17104 001**
 Repair Kit.: **3407 17104 900**



Displacement: 17ml/r
 Controlled flow: 16L/min
 Max. pressure: 15MPa(Without)
 Speed range: 500-4000r/min
 Rotation: R
 Fuel feed hole: M26×1.5
 Fuel discharge hole: M16×1.5

Drawing No.: **3407 1763 001**
 Repair Kit.: **3407 1763 900**

Cross Ref.: IA322377
 Application: Eicher

Pictures And/Or OEM Part Numbers are for reference purpose only.

Displacement: 17.5ml/r
Controlled flow: 16L/min
Max.pressure: 15MPa
Speed range: 500~3600r/min
Rotation: R
Fuel feed hole: M26×1.5
Fuel discharge hole: M16×1.5

SORL No.: **3407 18115 001**

Application: Mahindra Truck & Bus
7.2L Diesel Engine with 6Cyl.



Displacement: 9ml/r
Controlled flow: 7L/min
Max. pressure: 7MPa
Speed range: 500-7000r/min
Rotation: R
Fuel feed hole: Φ16
Fuel discharge hole: M16×1.5

Drawing No.: **3407 0917 001**
Repair Kit.: **3407 0917 900**

Cross Ref.: 490017,
26114665-1F
Application: Mahindra scpio

Displacement: 9ml/r
Controlled flow: 7L/min
Max. pressure: 7MPa
Speed range: 500-7000r/min
Rotation: R
Fuel feed hole: Φ16
Fuel discharge hole: M16×1.5

Drawing No.: **3407 0918 001**
Repair Kit.: **3407 0918 900**

Cross Ref.: 490018
Application: Mahindra scpio



Displacement: 7.3ml/r
Controlled flow: 7L/min
Max.pressure: 8.5MPa
Speed range: 500~7000r/min
Rotation: R
Fuel feed hole: Φ16
Fuel discharge hole: M14×1.5

SORL No.: **3407 0763 001**

Cross Ref: 17A0302664
Application: ASHOK LEYLAND DOST



Displacement: 10ml/r
Controlled flow: 6.5L/min
Max. pressure: 7.5MPa
Speed range: 500-7000r/min
Rotation: R
Fuel feed hole: Φ15
Fuel discharge hole: M16×1.5

Drawing No.: **3407 1018 001**
Repair Kit.: **3407 1018 900**

Cross Ref.: 490019
Application: Mahindra blero



Displacement: 17.4ml/r
Controlled flow: 16L/min
Max.pressure: 16MPa
Speed range: 500~3600r/min
Rotation: R
Fuel feed hole: M26×1.5
Fuel discharge hole: M16×1.5

SORL No.: **3407 17153 001**

Cross Ref: 2190 4660 0121
Application: TATA HCV
FORNI 1109 GEARBOX



Displacement: 9.5ml/r
Controlled flow: 7L/min
Max.pressure: 7MPa
Speed range: 500~7000r/min
Rotation: R
Fuel feed hole: Φ16
Fuel discharge hole: M16×1.5

SORL No.: **3407 0976 001**

Cross Ref: AM-28276385
Application: MAHINDRA XYLO E4



Displacement: 20ml/r
Controlled flow: 18L/min
Max.pressure: 16MPa
Speed range: 500~3600r/min
Rotation: R
Fuel feed hole: M26×1.5
Fuel discharge hole: M18×1.5

SORL No.: **3407 20132 001**

Cross Ref: 5091 4660 1601
Application: TATA 2818T 7



SORL No.: **YBZ07B-070/075**
 Drawing No.: **3407 0707 001**
 Repair Kit.: **3407 0707 900**

Displacement: 7.3ml/r
 Controlled flow: 7L/min
 Max. pressure: 7.5MPa
 Speed range: 500-8000r/min
 Rotation: R
 Fuel feed hole: $\Phi 16$
 Fuel discharge hole: M14 \times 1.5

Cross Ref.: 2818 4660 0104,
 7690 955 412
 Application: Tata Indica



Drawing No.: **3407 0729 001**
 Repair Kit.: **3407 0729 900**

Displacement: 7ml/r
 Controlled flow: 7L/min
 Max. pressure: 9MPa
 Speed range: 500-8000r/min
 Rotation: R
 Fuel feed hole: $\Phi 16$
 Fuel discharge hole: M16 \times 1.5

Cross Ref.: 2653 4660 0130
 Application: Tata Telcoline



SORL No.: **YBZ07C-070/080**
 Drawing No.: **3407 0708 001**
 Repair Kit.: **3407 0708 900**

Displacement: 7ml/r
 Controlled flow: 7.5L/min
 Max. pressure: 8MPa
 Speed range: 500-8000r/min
 Rotation: R
 Fuel feed hole: $\Phi 16$
 Fuel discharge hole: M16 \times 1.5

Cross Ref.: 2895 4660 0107
 Application: Tata Phoenix



Drawing No.: **3407 0741 001**
 Repair Kit.: **3407 0741 900**

Displacement: 7ml/r
 Controlled flow: 7L/min
 Max. pressure: 7MPa
 Speed range: 500-8000r/min
 Rotation: R
 Fuel feed hole: $\Phi 16$
 Fuel discharge hole: M14 \times 1.5

Cross Ref.: 2818 4660 0104,
 7690 955 412
 Application: Tata Indica



SORL No.: **3407 20133 001**

Displacement: 20ml/r
 Controlled flow: 16L/min
 Max. pressure: 16MPa
 Speed range: 500~3600r/min
 Rotation: L
 Fuel feed hole: M26 \times 1.5
 Fuel discharge hole: M18 \times 1.5

Cross Ref.: 2885 4660 0105
 Application: TATA Prima



Drawing No.: **3407 0762 001**
 Repair Kit.:

Displacement: 7.3ml/r
 Controlled flow: 7L/min
 Max. pressure: 8MPa
 Speed range: 500-7000r/min
 Rotation: R
 Fuel feed hole: $\Phi 16.8$
 Fuel discharge hole: M14 \times 1.5

Cross Ref.: 16R0400059
 Application: TATA VISTA



Drawing No.: **3407 0723 001**
 Repair Kit.: **3407 0723 900**

Displacement: 7ml/r
 Controlled flow: 7L/min
 Max. pressure: 8MPa
 Speed range: 500-8000r/min
 Rotation: R
 Fuel feed hole: $\Phi 16$
 Fuel discharge hole: M16 \times 1.5

Cross Ref.: 2826 4660 0136,
 2826 4660 0139
 Application: Tata Tml 207DI



Drawing No.: **3407 0765 001**
 Repair Kit.:

Displacement: 7.3ml/r
 Controlled flow: 6.9L/min
 Max. pressure: 8MPa
 Speed range: 400-7000r/min
 Rotation: R
 Fuel feed hole: $\Phi 16$
 Fuel discharge hole: M16 \times 1.5

Cross Ref.: TATA 5545 4660 0157
 Application: TATA ACE MEGA XL



Drawing No.: **3407 0725 001**
 Repair Kit.: **3407 0725 900**

Displacement: 7ml/r
 Controlled flow: 7L/min
 Max. pressure: 7MPa
 Speed range: 500-8000r/min
 Rotation: R
 Fuel feed hole: $\Phi 16$
 Fuel discharge hole: M16 \times 1.5

Cross Ref.: 2823 4660 0125
 Application: Tata Sumo 207/winger



SORL No.: **YBZ08T-060/113**
 Drawing No.: **3407 0829 001**
 Repair Kit.: **3407 0829 900**

Displacement: 8ml/r
 Controlled flow: 6L/min
 Max. pressure: 11.3MPa
 Speed range: 500-7000r/min
 Rotation: R
 Fuel feed hole: $\Phi 16$
 Fuel discharge hole: M16 \times 1.5

Cross Ref.: 5502 4660 0205,
 7613 955 159
 Application: Tata Safari Xenon



Displacement: 8ml/r
Controlled flow: 8.25L/min
Max. pressure: 11MPa
Speed range: 500-8000r/min
Rotation: R
Fuel feed hole: Φ 16
Fuel discharge hole: M16 \times 1.5

SORL No.: **YBZ08T1-090/100**
Drawing No.: **3407 0830 001**
Repair Kit.: **3407 0830 900**

Cross Ref.: 2641 4680 0155,
7613 955 138
Application: Tata LPK407



Displacement: 15ml/r
Controlled flow: 12L/min
Max. pressure: 12MPa
Speed range: 500-3000r/min
Rotation: R
Fuel feed hole: M26 \times 1.5
Fuel discharge hole: M18 \times 1.5

SORL No.: **YBZ15A1-120/120**
Drawing No.: **3407 1503 001**
Repair Kit.: **3407 1503 900**

Cross Ref.: 7672 955 253
Application: Tata HCV



Displacement: 14ml/r
Controlled flow: 9L/min
Max. pressure: 10MPa
Speed range: 500-4000r/min
Rotation: R
Fuel discharge hole: M16 \times 1.5
Fuel feed hole: M26 \times 1.5

SORL No.: **YBZ14A-090/100**
Drawing No.: **3407 1403 001**
Repair Kit.: **3407 1403 900**

Cross Ref.: 2641 4680 0143
Application: Tata LVC



Displacement: 17ml/r
Controlled flow: 16L/min
Max. pressure: 14MPa
Speed range: 500-4000r/min
Rotation: R
Fuel feed hole: M26 \times 1.5
Fuel discharge hole: M16 \times 1.5

Drawing No.: **3407 1757 001**
Repair Kit.: **3407 1757 900**

Cross Ref.: 2913 1246 2143
Application: Tata 3118



Displacement: 14ml/r
Controlled flow: 9L/min
Max. pressure: 12.5MPa
Speed range: 500-4000r/min
Rotation: R
Fuel feed hole: M26 \times 1.5
Fuel discharge hole: M16 \times 1.5

SORL No.: **YBZ14A1-090/125**
Drawing No.: **3407 1425 001**
Repair Kit.: **3407 1425 900**

Cross Ref.: 2153 4680 0104
Application: Tata MCV 1109



Displacement: 21ml/r
Controlled flow: 16L/min
Max. pressure: 18MPa(Without)
Speed range: 500-3500r/min
Rotation: R
Fuel feed hole: M26 \times 1.5
Fuel discharge hole: M18 \times 1.5

SORL No.: **YBZ21T-160**
Drawing No.: **3407 2107 001**
Repair Kit.: **3407 2107 900**

Cross Ref.: 7685 955 201
Application: Tata world Truck



Displacement: 15ml/r
Controlled flow: 12L/min
Max. pressure: 12MPa
Speed range: 500-3600r/min
Rotation: R
Fuel feed hole: M26 \times 1.5
Fuel discharge hole: M16 \times 1.5

SORL No.: **YBZ15-120/120**
Drawing No.: **3407 1501 001**
Repair Kit.: **3407 1501 900**

Cross Ref.: 2770 4600 0110
Application: Tata HCV



**ANHUI
TIANLI**



Displacement: 15ml/r
Controlled flow: 12L/min
Max. pressure: 12MPa
Speed range: 500-3000r/min
Rotation: R
Fuel feed hole: M26 \times 1.5
Fuel discharge hole: M16 \times 1.5

SORL No.: **YBZ15A-120/120**
Drawing No.: **3407 1502 001**
Repair Kit.: **3407 1502 900**

Cross Ref.: 2632 4660 0111,
7672 955 380
Application: Tata HCV



Controlled flow: 19L/min
Fuel feed hole: M27 \times 1.5
Fuel discharge hole: M20 \times 1.5
Displacement: 20ml/r
Speed range: 500-3200r/min
Max pressure: 14MPa
Rotation: R

Drawing No.: **3407 2141 001**

Cross Ref.: QC4DBE-ZC-20100
7679 955 618
Application: AnHui TianLi



Controlled flow: 17L/min
 Fuel feed hole: M26x1.5
 Fuel discharge hole: M18x1.5
 Displacement: 19ml/r
 Speed range: 5003600r/min
 Max pressure: 13MPa
 Rotation: R

SORL No.: **YBZ19S170/130**
 Drawing No.: **3407 1901 001**

Application: AnHui XingMa



Controlled flow: 18L/min
 Fuel feed hole: M27x1.5
 Fuel discharge hole: M18x1.5
 Displacement: 17ml/r
 Speed range: 5003200r/min
 Max pressure: 15MPa
 Rotation: R

Drawing No.: **3407 1764 001**

Cross Ref.: 271 460 02 80
 Application: BeiBen



Controlled flow: 24L/min
 Fuel feed hole: M30x2
 Fuel discharge hole: M20x1.5
 Displacement: 22ml/r
 Speed range: 5003600r/min
 Max pressure: 13.5MPa
 Rotation: R

SORL No.: **YBZ22240/135**
 Drawing No.: **3407 2201 001**

Application: AnHui XingMa



Controlled flow: 22L/min
 Fuel feed hole: M27x1.5
 Fuel discharge hole: M18x1.5
 Displacement: 21ml/r
 Speed range: 6003200r/min
 Max pressure: 15MPa
 Rotation: R
 Cross Ref.:
 2714600080(M4101-3407100)
 Application: BeiBen
 YuChai6A/6M diesel

Drawing No.: **3407 2150 001**



Controlled flow: 19L/min
 Fuel feed hole: M30x2
 Fuel discharge hole: M20x1.5
 Displacement: 22ml/r
 Speed range: 5003600r/min
 Max pressure: 13.5MPa
 Rotation: R

SORL No.: **YBZ22A190/135**
 Drawing No.: **3407 2202 001**

Application: AnHui XingMa



Controlled flow: 23L/min
 Fuel feed hole: $\Phi 23$
 Fuel discharge hole: M18x1.5
 Displacement: 21ml/r
 Speed range: 5003200r/min
 Max pressure: 15MPa
 Rotation: R

Drawing No.: **3407 2163 001**

Cross Ref.: 271 460 03 80
 Application: BeiBen



Controlled flow: 24L/min
 Fuel feed hole: M26x1.5
 Fuel discharge hole: M18x1.5
 Displacement: 22ml/r
 Speed range: 5003600r/min
 Max pressure: 13MPa
 Rotation: R

SORL No.: **YBZ22S240/130**
 Drawing No.: **3407 2204 001**

Cross Ref.: 1318634000039
 Application: AnHui XingMa



Controlled flow: 16L/min
 Fuel feed hole: M27x1.5
 Fuel discharge hole: M18x1.5
 Displacement: 16ml/r
 Speed range: 5004000r/min
 Max pressure: 13MPa
 Rotation: L

Drawing No.: **3407 6673 001**

Application: BeiBen

Pictures And/Or OEM Part Numbers are for reference purpose only.



Controlled flow: 16.7L/min
 Fuel feed hole: M27x1.5
 Fuel discharge hole: M18x1.5
 Displacement: 16ml/r
 Speed range: 5003200r/min
 Max pressure: 11MPa
 Rotation: L

Drawing No.: **3407 6674 001**

Application: BeiBen



Controlled flow: 7L/min
 Fuel feed tube: Φ16
 Fuel discharge hole: M16x1.5
 Displacement: 8ml/r
 Speed range: 5007000r/min
 Max pressure: 8MPa
 Rotation: R

SORL No.: **YBZ08H2070/080**
 Drawing No.: **3407 0808 001**

Cross Ref.: 1651634000091
 Application: BeiQi Foton



Controlled flow: 30L/min
 Fuel feed hole: M27x1.5
 Fuel discharge hole: M18x1.5
 Displacement: 32ml/r
 Speed range: 6003200r/min
 Max pressure: 15MPa
 Rotation: R

Drawing No.: **3407 3203 001**

Cross Ref.: 900 000 00 80
 Application: BeiBen



Controlled flow: 7L/min
 Fuel feed tube: Φ16
 Fuel discharge hole: M16x1.5
 Displacement: 8.3ml/r
 Speed range: 5008000r/min
 Max pressure: 8.5MPa
 Rotation: R

SORL No.: **YBZ08P2070/085**
 Drawing No.: **3407 0816 001**

Cross Ref.: 1648634000110
 Application: BeiQi Foton
 BJ6486B1DBA



Displacement: 21ml/r
 Controlled flow: 20L/min
 Max. pressure: 15MPa(Without)
 Speed range: 500-3500r/min
 Rotation: R
 Fuel feed hole: M26x1.5
 Fuel discharge hole: M18x1.5

Drawing No.: **3407 2175 001**

Application: Axor



Controlled flow: 7L/min
 Fuel feed tube: Φ12
 Fuel discharge hole: M16x1.5
 Displacement: 8.3ml/r
 Speed range: 5007000r/min
 Max pressure: 8MPa
 Rotation: R

SORL No.: **YBZ08P3070/080**
 Drawing No.: **3407 0817 001**

Cross Ref.: 1102734001460
 Application: BeiQi Foton



**BEIQI
 FOTON**



Controlled flow: 7.6L/min
 Fuel feed tube: Φ16
 Fuel discharge hole: M16x1.5
 Displacement: 8ml/r
 Speed range: 5008000r/min
 Max pressure: 8MPa
 Rotation: R

SORL No.: **YBZ08P4078/080**
 Drawing No.: **3407 0818 001**

Cross Ref.: 1104934000014
 Application: BeiQi Foton
 BJ1049V8JD6-3



Controlled flow: 7.8L/min
 Fuel feed tube: Φ10
 Fuel discharge hole: M16x1.5
 Displacement: 7.4ml/r
 Speed range: 5008000r/min
 Max pressure: 7MPa
 Rotation: R

SORL No.: **YBZ07Q078/070**
 Drawing No.: **3407 0711 001**

Cross Ref.: 1647634000040
 Application: BeiQi Foton
 BJ6476B1DXAS1



Controlled flow: 7L/min
 Fuel feed tube: Φ15
 Fuel discharge hole: M16x1.5
 Displacement: 8.3ml/r
 Speed range: 5008000r/min
 Max pressure: 8MPa
 Rotation: R

Drawing No.: **3407 0858 001**

Cross Ref.: 1647634000025/
 P0340030004A0
 Application: BeiQi Foton

Pictures And/Or OEM Part Numbers are for reference purpose only.



Controlled flow: 7L/min
 Fuel feed tube: $\phi 12$
 Fuel discharge hole: M12x1.25
 Displacement: 9.6ml/r
 Speed range: 6008500r/min
 Max pressure: 8MPa
 Rotation: R

SORL No.: **YBZ10B1060/085**
 Drawing No.: **3407 1002 001**

Cross Ref.: 1648634000056
 Application: BeiQi Foton



Controlled flow: 16L/min
 Fuel feed hole: M26x1.5
 Fuel discharge hole: M18x1.5
 Displacement: 14ml/r
 Speed range: 5003900r/min
 Max pressure: 13.5MPa
 Rotation: R

SORL No.: **YBZ14S160/130**
 Drawing No.: **3407 1413 001**

Cross Ref.: 1417034000004
 Application: Steyr Auman



Controlled flow: 7L/min
 Fuel feed tube: $\phi 16$
 Fuel discharge hole: M16x1.5
 Displacement: 11ml/r
 Speed range: 5008000r/min
 Max pressure: 8.5MPa
 Rotation: R

SORL No.: **YBZ11H075/085**
 Drawing No.: **3407 1106 001**

Cross Ref.: 1648634000025
 7079 955 105
 Application: BeiQi Foton

Controlled flow: 7.5L/min
 Fuel feed tube: $\phi 16$
 Fuel discharge hole: M16x1.5
 Displacement: 11ml/r
 Speed range: 5008000r/min
 Max pressure: 8MPa
 Rotation: R

SORL No.: **YBZ11P075/080**
 Drawing No.: **3407 1111 001**

Cross Ref.: 1102734000096
 Application: BeiQi Foton
 BJ1027V2MW5



Controlled flow: 4.75L/min
 Fuel feed tube: $\phi 16$
 Fuel discharge hole: M16x1.5
 Displacement: 5ml/r
 Speed range: 5007500r/min
 Max pressure: 8MPa
 Rotation: R

Drawing No.: **3407 0501 001**

Cross Ref.: LK-3407010B
 Application: BYD F0



Controlled flow: 7.5L/min
 Fuel feed tube: $\phi 16$
 Fuel discharge hole: M16x1.5
 Displacement: 11ml/r
 Speed range: 5008000r/min
 Max pressure: 8MPa
 With reservoir
 Rotation: R

SORL No.: **YBZ11P1075/080**
 Drawing No.: **3407 1112 001**

Cross Ref.: 11027340000303
 Application: BeiQi Foton



Controlled flow: 8.5L/min
 Fuel feed tube: $\phi 16$
 Fuel discharge hole: M16x1.5
 Displacement: 7ml/r
 Speed range: 5007000r/min
 Max pressure: 8.5MPa
 Rotation: R

Drawing No.: **3407 0720 001**

Cross Ref.: F3-3407000-C
 Application: BYD F3



Controlled flow: 7L/min
 Fuel feed hole: $\phi 16$
 Fuel discharge hole: M16x1.5
 Displacement: 11ml/r
 Speed range: 5008000r/min
 Max pressure: 8MPa
 Rotation: R

SORL No.: **YBZ11Z070/080**
 Drawing No.: **3407 1118 001**

Cross Ref.: 1102734000013
 1027AEF3-3407010
 Application: BeiQi Foton



Controlled flow: 8L/min
 Fuel feed tube: $\phi 16$
 Fuel discharge hole: M16x1.5
 Displacement: 8.8ml/r
 Speed range: 5008000r/min
 Max pressure: 8.3MPa
 Rotation: R

Drawing No.: **3407 0923 001**

Cross Ref.: EG-3407 010
 Application: BYD F6

Pictures And/Or OEM Part Numbers are for reference purpose only.

Controlled flow: 16L/min
 Fuel feed hole: M27x1.5
 Fuel discharge hole: M16x1.5
 Displacement: 14ml/r
 Speed range: 5003600r/min
 Max pressure: 13MPa
 Rotation: L

Cross Ref.:3082PE3406010
 Application: ChangSha Foton
 BJ3082PE

Drawing No.: 3407 1419 001



Controlled flow: 7.5L/min
 Fuel feed tube: Φ 16
 Fuel discharge hole: M16x1.5
 Displacement: 8ml/r
 Speed range: 5007000r/min
 Max pressure: 10MPa
 Rotation: R

Cross Ref.: 1103634000043
 Application: ChangSha Foton
 1036V3JE6-03Z054

Drawing No.: 3407 0857 001

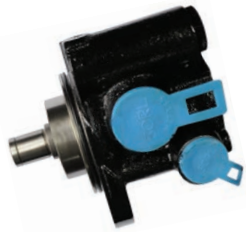

Controlled flow: 10L/min
 Fuel feed hole: Φ 18
 Fuel discharge hole: M16x1.5
 Displacement: 14ml/r
 Speed range: 5003200r/min
 Max pressure: 10MPa
 Rotation: L

Cross Ref.: 1108334000006
 Application: ChangSha Foton
 BJ1083VDJFD-MB

Drawing No.: 3407 1421 001



Displacement: 8.3ml/r
 Controlled flow: 8L/min
 Max.pressure: 8.5MPa
 Speed range: 500~6000r/min
 Rotation: R
 Fuel feed hole: Φ 16
 Fuel discharge hole: M16x1.5

Cross Ref: P1340030001A0,
 7079 955 186
 Application: FOTON PICKUP

SORL No.: 3407 08180 001



Controlled flow: 13L/min
 Fuel feed hole: M27x1.5
 Fuel discharge hole: M16x1.5
 Displacement: 14ml/r
 Speed range: 5003200r/min
 Max pressure: 15MPa
 Rotation: L

Cross Ref.: G0340030014A0
 Application: ChangSha Foton

Drawing No.: 3407 1432 001



Controlled flow: 7.6L/min
 Fuel feed tube: Φ 16
 Fuel discharge hole: M16x1.5
 Displacement: 8.3ml/r
 Speed range: 5008000r/min
 Max pressure: 8MPa
 Rotation: R

Cross Ref.: 1104934000014
 Application: ChangSha Foton
 BJ1049V8JD6-3

Drawing No.: 3407 0859 001



Controlled flow: 13L/min
 Fuel feed hole: M27x1.5
 Fuel discharge hole: M16x1.5
 Displacement: 14ml/r
 Speed range: 5003200r/min
 Max pressure: 13MPa
 Rotation: L

Cross Ref.: G0340030032A0
 Application: ChangSha Foton

Drawing No.: 3407 1437 001



Controlled flow: 16L/min
 Fuel feed hole: M20x1.5
 Fuel discharge hole: M16x1.5
 Displacement: 14ml/r
 Speed range: 5003600r/min
 Max pressure: 10MPa
 Rotation: L

Cross Ref.: 13101340M0003
 Application: ChangSha Foton
 BJ3077CE(H6)

Drawing No.: 3407 1416 001



Controlled flow: 15L/min
 Fuel feed hole: M27x1.5
 Fuel discharge hole: M20x1.5
 Displacement: 15ml/r
 Speed range: 5003600r/min
 Max pressure: 11MPa
 Rotation: L

Cross Ref.: 13116342M0010
 Application: ChangSha Foton

Drawing No.: 3407 1543 001

Pictures And/Or OEM Part Numbers are for reference purpose only.



Controlled flow: 18L/min
 Fuel feed hole: M20x1.5
 Fuel discharge hole: M16x1.5
 Displacement: 16ml/r
 Speed range: 5003200r/min
 Max pressure: 13MPa
 Rotation: L

Cross Ref.: 13042340M3014
 Application: ChangSha Foton
 3042D8PFA-02Z092

Drawing No.: **3407 1687 001**



Controlled flow: 12L/min
 Fuel feed hole: M27x1.5
 Fuel discharge hole: M18x1.5
 Displacement: 16ml/r
 Speed range: 5003600r/min
 Max pressure: 13MPa
 Rotation: L

Cross Ref.: 13031340M0026
 Application: ChangSha Foton
 BJ3067ARG1

Drawing No.: **3407 1734 001**



Controlled flow: 20L/min
 Fuel feed hole: M27x1.5
 Fuel discharge hole: M20x1.5
 Displacement: 16ml/r
 Speed range: 5003200r/min
 Max pressure: 14MPa
 Rotation: L

Cross Ref.: 13137340M1001
 Application: ChangSha Foto
 BJ3137CE

Drawing No.: **3407 1730 001**



Controlled flow: 12L/min
 Fuel feed hole: M27x1.5
 Fuel discharge hole: M20x1.5
 Displacement: 16ml/r
 Speed range: 5003200r/min
 Max pressure: 13MPa
 Rotation: L

Cross Ref.: G0340030013A0
 Application: ChangSha Foton

Drawing No.: **3407 1740 001**



Controlled flow: 15L/min
 Fuel feed hole: M27x1.5
 Fuel discharge hole: M20x1.5
 Displacement: 16ml/r
 Speed range: 5003200r/min
 Max pressure: 10MPa
 Rotation: R

Cross Ref.: 13161342M0007
 Application: ChangSha Foton
 3100CE 3097CE

Drawing No.: **3407 1731 001**



Controlled flow: 15L/min
 Fuel feed hole: M27x1.5
 Fuel discharge hole: M18x1.5
 Displacement: 16ml/r
 Speed range: 5003600r/min
 Max pressure: 15MPa
 Rotation: R

Cross Ref.: G0340030011A0
 Application: ChangSha Foton

Drawing No.: **3407 1745 001**



Controlled flow: 16L/min
 Fuel feed hole: M27x1.5
 Fuel discharge hole: M18x1.5
 Displacement: 17ml/r
 Speed range: 5003200r/min
 Max pressure: 13MPa
 Rotation: L

Cross Ref.: G0340030004A0
 Application: ChangSha Foton
 3102V4PDB-A1Z005

Drawing No.: **3407 1732 001**



Controlled flow: 13L/min
 Fuel feed hole: M20x1.5
 Fuel discharge hole: M20x1.5
 Displacement: 16ml/r
 Speed range: 5003200r/min
 Max pressure: 13MPa
 Rotation: L

Cross Ref.: G0340030012A0
 Application: ChangSha Foton

Drawing No.: **3407 6605 001**



Controlled flow: 12L/min
 Fuel feed hole: M27x1.5
 Fuel discharge hole: M18x1.5
 Displacement: 16ml/r
 Speed range: 5003600r/min
 Max pressure: 13MPa
 Rotation: R

Cross Ref.: 13042340M0230
 Application: ChangSha Foton
 BJ3064PMG1

Drawing No.: **3407 1733 001**



Controlled flow: 13L/min
 Fuel feed hole: M20x1.5
 Fuel discharge hole: M16x1.5
 Displacement: 16ml/r
 Speed range: 5003200r/min
 Max pressure: 15MPa
 Rotation: L

Cross Ref.: G0340030010A0
 Application: ChangSha Foton
 3082PEJ24108L36-1

Drawing No.: **3407 6608 001**

Pictures And/Or OEM Part Numbers are for reference purpose only.



Drawing No.: 3407 6622 001

Controlled flow: 18L/min
 Fuel feed hole: M27x1.5
 Fuel discharge hole: M16x1.5
 Displacement: 16ml/r
 Speed range: 5003600r/min
 Max pressure: 13MPa
 Rotation: L

Cross Ref.: G0340030015A0
 Application: ChangSha Foton



SORL No.: YBZ16D6B-130/130L
 Drawing No.: 3407 1632 001

Controlled flow: 13L/min
 Fuel feed tube: ϕ 22
 Fuel discharge hole: M18x1.5
 Displacement: 16ml/r
 Speed range: 5003200r/min
 Max pressure: 13MPa
 Rotation: L

Cross Ref.: 4102BZ12P.30.10
 Application: Chao Chai



Drawing No.: 3407 6630 001

Controlled flow: 20L/min
 Fuel feed hole: M27x1.5
 Fuel discharge hole: M20x1.5
 Displacement: 16ml/r
 Speed range: 5003200r/min
 Max pressure: 15MPa
 Rotation: L

Cross Ref.: G0340030016A0
 Application: ChangSha Foton
 3112PEX56105Lj42-12



SORL No.: YBZ16D6C-130/130L
 Drawing No.: 3407 1633 001

Controlled flow: 13L/min
 Fuel feed tube: ϕ 22
 Fuel discharge hole: M18x1.5
 Displacement: 16ml/r
 Speed range: 5003200r/min
 Max pressure: 13MPa
 Rotation: L

Cross Ref.: 4105Q101A.30.10
 Application: Chao Chai



DCD



SORL No.: YBZ16D6D-090/100L
 Drawing No.: 3407 1634 001

Controlled flow: 9L/min
 Fuel feed tube: ϕ 16.5
 Fuel discharge hole: M18x1.5
 Displacement: 16ml/r
 Speed range: 5003200r/min
 Max pressure: 10MPa
 Rotation: L

Cross Ref.: 4100ZL-18A.30.10
 Application: Chao Chai



SORL No.: YBZ16D6-130/130L
 Drawing No.: 3407 1630 001

Controlled flow: 13L/min
 Fuel feed hole: M20x1.5
 Fuel discharge hole: M20x1.5
 Displacement: 16ml/r
 Speed range: 5003200r/min
 Max pressure: 13MPa
 Rotation: L

Cross Ref.: 4D47T1-1.30.10
 Application: Chao Chai



SORL No.: YBZ16D2-160/105L
 Drawing No.: 3407 1658 001

Controlled flow: 16L/min
 Fuel feed hole: M24x2
 Fuel discharge hole: M20x1.5
 Displacement: 16ml/r
 Speed range: 5003200r/min
 Max pressure: 10.5MPa
 Rotation: L

Cross Ref.: 6105Q26d.30.10B
 Application: Chao Chai



SORL No.: YBZ16D6A-130/130L
 Drawing No.: 3407 1631 001

Controlled flow: 13L/min
 Fuel feed tube: ϕ 22
 Fuel discharge hole: M18x1.5
 Displacement: 16ml/r
 Speed range: 5003200r/min
 Max pressure: 13MPa
 Rotation: L

Cross Ref.: 4D47T16.30.10
 Application: Chao Chai



CDW



Controlled flow: 11L/min
 Fuel feed hole: M18x1.5
 Fuel discharge hole: M18x1.5
 Displacement: 14ml/r
 Speed range: 6003200r/min
 Max pressure: 10.5MPa
 Rotation: L

Cross Ref.: 344260304
 Application: WangPai

Drawing No.: 3407 1424 001



Controlled flow: 16L/min
 Fuel feed hole: M27x1.5
 Fuel discharge hole: M20x1.5
 Displacement: 17ml/r
 Speed range: 5003600r/min
 Max pressure: 11MPa
 Rotation: L

Cross Ref.: 344217
 ZYB1016L/11A-000
 Application: WangPai

Drawing No.: 3407 1725 001



Controlled flow: 12L/min
 Fuel feed hole: M27x1.5
 Fuel discharge hole: M18x1.5
 Displacement: 16.8ml/r
 Speed range: 5003600r/min
 Max pressure: 13MPa
 Rotation: R

Cross Ref.: 344219304
 Application: WangPai

Drawing No.: 3407 1667 001



CHONGQING LIFAN



Controlled flow: 16L/min
 Fuel feed hole: M27x1.5
 Fuel discharge hole: M16x1.5
 Displacement: 16ml/r
 Speed range: 5003600r/min
 Max pressure: 13MPa
 Rotation: L

Cross Ref.: 13062340M1005
 Application: WangPai

Drawing No.: 3407 1668 001



Displacement: 7ml/r
 Controlled flow: 5.3L/min
 Max pressure: 5.8MPa
 Speed range: 500-7000r/min
 Rotation: R
 Fuel feed hole: Φ16
 Fuel discharge hole: M16x1.5

SORL No.: YBZ07L-053/058
 Drawing No.: 3407 0709 001

Application: LF7132



Controlled flow: 13L/min
 Fuel feed hole: M27x1.5
 Fuel discharge hole: M16x1.5
 Displacement: 16ml/r
 Speed range: 5003200r/min
 Max pressure: 13MPa
 Rotation: L

Cross Ref.: 3442153004
 Application: WangPai

Drawing No.: 3407 1669 001



Displacement: 8.3ml/r
 Controlled flow: 7L/min
 Max pressure: 8MPa
 Speed range: 500-7000r/min
 Rotation: R
 Fuel feed hole: Φ16
 Fuel discharge hole: M16x1.5

SORL No.: YBZ07L-053/058
 Drawing No.: 3407 0862 001

Application: LF7162C



Controlled flow: 13L/min
 Fuel feed hole: M27x1.5
 Fuel discharge hole: M16x1.5
 Displacement: 16ml/r
 Speed range: 6003200r/min
 Max pressure: 13.5MPa
 Rotation: L

Cross Ref.: 344216304
 Application: WangPai

Drawing No.: 3407 1670 001



YEMA AUTO

Pictures And/Or OEM Part Numbers are for reference purpose only.



Drawing No.: 3407 0722 001

Controlled flow: 6.5L/min
 Fuel feed tube: $\phi 12$
 Fuel discharge hole: M16x1.5
 Displacement: 7.4ml/r
 Speed range: 5008000r/min
 Max pressure: 6.5MPa
 Rotation: R
 With reservoir

Cross Ref.: FAM3407100B
 Application: ChuanqiYEMA



SORL No.: YBZ16B1125/140
 Drawing No.: 3407 1613 001

Controlled flow: 12.5L/min
 Fuel feed hole: $\phi 22$
 Fuel discharge hole: M20x1.5
 Displacement: 16ml/r
 Speed range: 5003200r/min
 Max pressure: 14MPa
 Rotation: R

Cross Ref.: 3406B-010
 Application: Dongfeng EQ145



DONGFENG



SORL No.: YBZ16C200/140
 Drawing No.: 3407 1614 001

Controlled flow: 20L/min
 Fuel feed hole: M30x2
 Fuel discharge hole: M20x1.5
 Displacement: 16ml/r
 Speed range: 5003200r/min
 Max pressure: 14MPa
 Rotation: R

Cross Ref.: 3406G1-010
 Application: Dongfeng EQ153



SORL No.: YBZ16B125/105
 Drawing No.: 3407 1610 001

Controlled flow: 12.5L/min
 Fuel feed hole: $\phi 22$
 Fuel discharge hole: M20x1.5
 Displacement: 16ml/r
 Speed range: 5003200r/min
 Max pressure: 10.5MPa
 Rotation: R

Cross Ref.: 3406B-010
 Application: Dongfeng EQ145



SORL No.: YBZ16C-150/140
 Drawing No.: 3407 1615 001

Controlled flow: 20L/min
 Fuel feed hole: M30x2
 Fuel discharge hole: M20x1.5
 Displacement: 16ml/r
 Speed range: 5003200r/min
 Max pressure: 14MPa
 Rotation: R

Cross Ref.: 3406A-010
 Application: Dongfeng EQ153



SORL No.: YBZ16B125/140
 Drawing No.: 3407 1611 001

Controlled flow: 12.5L/min
 Fuel feed hole: $\phi 22$
 Fuel discharge hole: M20x1.5
 Displacement: 16ml/r
 Speed range: 5003200r/min
 Max pressure: 14MPa
 Rotation: R

Cross Ref.: 3406B-010
 Application: Dongfeng EQ145



SORL No.: YBZ16C1200/140
 Drawing No.: 3407 1616 001

Controlled flow: 20L/min
 Fuel feed hole: M30x2
 Fuel discharge hole: M20x1.5
 Displacement: 16ml/r
 Speed range: 5003200r/min
 Max pressure: 14MPa
 Rotation: R

Cross Ref.: 3406G-010-B
 Application: Dongfeng EQ153



SORL No.: YBZ16B1125/105
 Drawing No.: 3407 1612 001

Controlled flow: 12.5L/min
 Fuel feed hole: $\phi 22$
 Fuel discharge hole: M20x1.5
 Displacement: 16ml/r
 Speed range: 5003200r/min
 Max pressure: 10.5MPa
 Rotation: R

Cross Ref.: 3406B-010
 Application: Dongfeng EQ145



SORL No.: YBZ16C1-200/140
 Drawing No.: 3407 6632 001

Controlled flow: 20L/min
 Fuel feed hole: M30x2
 Fuel discharge hole: M20x1.5
 Displacement: 16ml/r
 Speed range: 5003200r/min
 Max pressure: 14MPa
 Rotation: R

Cross Ref.: 3406-010-C

Controlled flow: 10L/min
 Fuel feed hole: M20x1.5
 Fuel discharge hole: M18x1.5
 Displacement: 12ml/r
 Speed range: 5003000r/min
 Max pressure: 10MPa
 Rotation: L

SORL No.: **YBZ12A1100/100L**
 Drawing No.: **3407 1203 001**

Cross Ref.: 3407010-3C3
 Application: FAW 3 tons



Controlled flow: 6L/min
 Fuel feed hole: M18x1.5
 Fuel discharge hole: M16x1.5
 Displacement: 9.6ml/r
 Speed range: 5003600r/min
 Max pressure: 10MPa
 Rotation: L

Drawing No.: **3407 0930 001**

Cross Ref.: 3407020-D538E
 Application: FAW light truck



Controlled flow: 15L/min
 Fuel feed hole: M24x1.5
 Fuel discharge hole: M18x1.5
 Displacement: 13.5ml/r
 Speed range: 5003600r/min
 Max pressure: 13MPa
 Rotation: L

SORL No.: **YBZ14E150/130L**
 Drawing No.: **3407 1411 001**

Cross Ref.: 3407020-271
 Application: FAW



Controlled flow: 10L/min
 Fuel feed hole: Φ 16
 Fuel discharge hole: M16x1.5
 Displacement: 11ml/r
 Speed range: 5007000r/min
 Max pressure: 10.3MPa
 Rotation: R

Drawing No.: **3407 1123 001**

Cross Ref.: S340702090DC00
 Application: FAW



Controlled flow: 14L/min
 Fuel feed hole: M18x1.5
 Fuel discharge hole: M16x1.5
 Displacement: 16.8ml/r
 Speed range: 5003600r/min
 Max pressure: 10MPa
 Rotation: L

SORL No.: **YBZ16A140/100L**
 Drawing No.: **3407 1601 001**

Cross Ref.: 3407020A8EA1
 Application: FAW 6110 diesel



Controlled flow: 9L/min
 Fuel feed hole: M18x1.5
 Fuel discharge hole: M18x1.5
 Displacement: 12ml/r
 Speed range: 5002800r/min
 Max pressure: 8MPa
 Rotation: L

SORL No.: **YBZ12090/080L**
 Drawing No.: **3407 1201 001**

Cross Ref.: 3407020-KA-021
 Application: FAW 3 tons



Controlled flow: 16L/min
 Fuel feed hole: M18x1.5
 Fuel discharge hole: M16x1.5
 Displacement: 16.8ml/r
 Speed range: 5003600r/min
 Max pressure: 13MPa
 Rotation: L

SORL No.: **YBZ16A160/130L**
 Drawing No.: **3407 1603 001**

Application: FAW6110 diesel



Controlled flow: 7.5L/min
 Fuel feed hole: Φ 16
 Fuel discharge hole: M18x1.5
 Displacement: 12ml/r
 Speed range: 5003000r/min
 Max pressure: 10MPa
 Rotation: L

SORL No.: **YBZ12A075/100L**
 Drawing No.: **3407 1202 001**

Cross Ref.: 3407010-5K1
 Application: FAW 3 tons



Controlled flow: 14L/min
 Fuel feed hole: M24x1.5
 Fuel discharge hole: M18x1.5
 Displacement: 16ml/r
 Speed range: 5003600r/min
 Max pressure: 10MPa
 Rotation: L

SORL No.: **YBZ16A3140/100L**
 Drawing No.: **3407 1606 001**

Cross Ref.: 3407010-0A2
 Application: FAW4110 diesel



Controlled flow: 14L/min
 Fuel feed hole: M24x1.5
 Fuel discharge hole: M18x1.5
 Displacement: 16ml/r
 Speed range: 5003600r/min
 Max pressure: 10MPa
 Rotation: L

SORL No.: **YBZ16A4160/100L**
 Drawing No.: **3407 1607 001**

Cross Ref.: 3407010-3A0
 Application: FAW4110 diesel



Controlled flow: 16L/min
 Fuel feed tube: Φ 23
 Fuel discharge hole: M18x1.5
 Displacement: 18ml/r
 Speed range: 6003200r/min
 Max pressure: 16MPa
 Rotation: R

Drawing No.: **3407 1818 001**

Cross Ref.: 3407020-SY
 Application: FAW



Controlled flow: 14L/min
 Fuel feed hole: M24x1.5
 Fuel discharge hole: M18x1.5
 Displacement: 16ml/r
 Speed range: 5003600r/min
 Max pressure: 10MPa
 Rotation: L

SORL No.: **YBZ16A4140/100L**
 Drawing No.: **3407 1608 001**

Cross Ref.: 3407010-3A0
 Application: FAW4110 diesel



Controlled flow: 16L/min
 Fuel feed hole: Φ 23
 Fuel discharge hole: M18x1.5
 Displacement: 18.4ml/r
 Speed range: 6003200r/min
 Max pressure: 16MPa
 (Without safety valve)
 Rotation: L

Drawing No.: **3407 1821 001**

Cross Ref.: 3407020-K04-C00
 Application: FAW military



Controlled flow: 16L/min
 Fuel feed tube: Φ 22
 Fuel discharge hole: M18x1.5
 Displacement: 18ml/r
 Speed range: 6003200r/min
 Max pressure: 15MPa
 Rotation: L

Drawing No.: **3407 1809 001**

Cross Ref.: 3407020-646
 Application: FAW



Controlled flow: 14L/min
 Fuel feed hole: M27x1.5
 Fuel discharge hole: M18x1.5
 Displacement: 20ml/r
 Speed range: 5003600r/min
 Max pressure: 14MPa
 Rotation: R

Drawing No.: **3407 2026 001**

Application: FAW Hongta



Controlled flow: 16L/min
 Fuel feed tube: Φ 23
 Fuel discharge hole: M18x1.5
 Displacement: 18ml/r
 Speed range: 6003200r/min
 Max pressure: 15MPa
 (Without safety valve)
 Rotation: R

Drawing No.: **3407 1812 001**

Cross Ref.: 3407020-844-C00
 (2407020M00A703R)
 Application: FAW



Controlled flow: 25L/min
 Fuel feed tube: Φ 22
 Fuel discharge hole: M18x1.5
 Displacement: 22ml/r
 Speed range: 6003200r/min
 Max pressure: 15MPa
 Rotation: L

Drawing No.: **3407 2206 001**

Cross Ref.: 3407020-655
 Application: FAW PTO



Controlled flow: 16L/min
 Fuel feed tube: Φ 24
 Fuel discharge hole: M18x1.5
 Displacement: 18ml/r
 Speed range: 6003200r/min
 Max pressure: 16MPa
 (Without safety valve)
 Rotation: L

Drawing No.: **3407 1814 001**

Cross Ref.: 2S3407020-888-C00
 (S3407020-63A-0888)
 Application: FAW



Controlled flow: 25L/min
 Fuel feed tube: Φ 23
 Fuel discharge hole: M18x1.5
 Displacement: 22ml/r
 Speed range: 6003200r/min
 Max pressure: 15MPa
 (Without safety valve)
 Rotation: L

Drawing No.: **3407 2209 001**

Cross Ref.: 3407020-6111776
 Application: FAW



Controlled flow: 25L/min
 Fuel feed tube: $\Phi 23$
 Fuel discharge hole: M18x1.5
 Displacement: 22ml/r
 Speed range: 6003200r/min
 Max pressure: 15MPa
 (Without safety valve)
 Rotation: R

Drawing No.: 3407 2210 001

Cross Ref.: 3407020-M850777
 Application: FAW



Controlled flow: 8.2L/min
 Fuel feed tube: $\Phi 16$
 Fuel discharge hole: M16x1.5
 Displacement: 8.3ml/r
 Speed range: 5007000r/min
 Max pressure: 8MPa
 Rotation: R

SORL No.: YBZ08H3082/080
 Drawing No.: 3407 0809 001

Cross Ref.: WP8013



Controlled flow: 25L/min
 Fuel feed tube: $\Phi 23$
 Fuel discharge hole: M18x1.5
 Displacement: 22ml/r
 Speed range: 6003200r/min
 Max pressure: 15MPa
 Rotation: L

Drawing No.: 3407 2212 001

Cross Ref.: 3407020-63J0801
 Application: FAW



Controlled flow: 8.2L/min
 Fuel feed hole: $\Phi 16$
 Fuel discharge hole: M16x1.5
 Displacement: 8.3ml/r
 Speed range: 5007000r/min
 Max pressure: 8MPa
 Rotation: R

SORL No.: YBZ08P6082/080
 Drawing No.: 3407 0820 001

Cross Ref.: WP8006



Controlled flow: 30L/min
 Fuel feed tube: $\Phi 23$
 Fuel discharge hole: M18x1.5
 Displacement: 30ml/r
 Speed range: 6003200r/min
 Max pressure: 15MPa
 (Without safety valve)
 Rotation: R

Drawing No.: 3407 3005 001

Cross Ref.: 3407020-999-C01
 Application: FAW



Controlled flow: 8.2L/min
 Fuel feed hole: $\Phi 16$
 Fuel discharge hole: M16x1.5
 Displacement: 8.3ml/r
 Speed range: 5007000r/min
 Max pressure: 8MPa
 Rotation: R

SORL No.: YBZ08P7A082/080
 Drawing No.: 3407 0822 001

Cross Ref.: WP8004



Controlled flow: 10L/min
 Fuel feed tube: $\Phi 16.5$
 Fuel discharge hole: M16x1.5
 Displacement: 16ml/r
 Speed range: 5003200r/min
 Max pressure: 10MPa
 Rotation: L

Drawing No.: 3407 6626 001

Cross Ref.: 3407100-D12
 Application: FAW Hongta



ANKAI



HENGWEI



Controlled flow: 14L/min
 Fuel feed hole: M24x1.5
 Fuel discharge hole: M18x1.5
 Displacement: 16ml/r
 Speed range: 5003600r/min
 Max pressure: 10MPa
 Rotation: L

Drawing No.: 3407 1688 001

Cross Ref.: 3407010-KB01
 Application: Kassbohrer



Controlled flow: 14L/min
 Fuel feed hole: M24x1.5
 Fuel discharge hole: M18x1.5
 Displacement: 16ml/r
 Speed range: 5003600r/min
 Max pressure: 10MPa
 Rotation: L

Drawing No.: **3407 1689 001**

Cross Ref.: 3407010-(2C6)
 Application: Kassbohrer



Controlled flow: 8.3L/min
 Fuel feed tube: Φ15
 Fuel discharge hole: M16_ix1.5
 Displacement: 8ml/r
 Speed range: 5008000r/min
 Max pressure: 7.8MPa
 Rotation: R

SORL No.: **YBZ08K083/078**
 Drawing No.: **3407 0811 001**

Cross Ref.: 5710026300
 Application: santafe 2.0

Controlled flow: 7.6L/min
 Fuel feed tube: Φ16
 Fuel discharge hole: M16x1.5
 Displacement: 8ml/r
 Speed range: 5007000r/min
 Max pressure: 8.5MPa
 Rotation: R

SORL No.: **YBZ08L1076/085**
 Drawing No.: **3407 0813 001**

Cross Ref.: 5710026300/A
 7078 955 617
 Application: santa fe 1.8T



Controlled flow: 8.5L/min
 Fuel feed tube: Φ13.5
 Fuel discharge hole: M16x1.5
 Displacement: 8.3ml/r
 Speed range: 5008000r/min
 Max pressure: 8MPa
 With reservior
 Rotation: R

Drawing No.: **3407 0844 001**

Cross Ref.: 3407010-064
 Application: GAC GONOW



Controlled flow: 7.5L/min
 Fuel feed tube: Φ16
 Fuel discharge hole: M16x1.5
 Displacement: 8.3ml/r
 Speed range: 5007000r/min
 Max pressure: 8MPa
 Rotation: R

SORL No.: **YBZ08P1075/080**
 Drawing No.: **3407 0815 001**

Cross Ref.: SDH3407100TKG00
 Application: HAWTAI MOTOR



Controlled flow: 7.5L/min
 Fuel feed tube: Φ16
 Fuel discharge hole: M16x1.5
 Displacement: 9.3ml/r
 Speed range: 5008000r/min
 Max pressure: 8MPa
 Rotation: R

Drawing No.: **3407 1026 001**

Cross Ref.: 3407010
 Application: GAC GONOW



Controlled flow: 7.5L/min
 Fuel feed tube: Φ16
 Fuel discharge hole: M16x1.5
 Displacement: 8.3ml/r
 Speed range: 5008000r/min
 Max pressure: 8MPa
 Rotation: R

Drawing No.: **3407 0832 001**

Cross Ref.: 34071200A03
 Application: HAWTAI MOTOR
 B21 B11

Controlled flow: 8.35L/min
 Fuel feed tube: Φ15
 Fuel discharge hole: M16x1.5
 Displacement: 8ml/r
 Speed range: 5008000r/min
 Max pressure: 8MPa
 Rotation: R

Drawing No.: **3407 0834 001**

Application: HAWTAI MOTOR
 B35



Drawing No.: 3407 0852 001

Controlled flow: 8.3L/min
 Fuel feed tube: $\phi 16$
 Fuel discharge hole: M16x1.5
 Displacement: 8.3ml/r
 Speed range: 5008000r/min
 Max pressure: 8MPa
 Rotation: R

Application: HAWTAI MOTOR B35



Drawing No.: 3407 1016 001

Controlled flow: 6.5L/min
 Fuel feed tube: $\phi 12$
 Fuel discharge hole: M16x1.5
 Displacement: 9.6ml/r
 Speed range: 5008000r/min
 Max pressure: 8MPa
 Rotation: R

Cross Ref.: 3407010T00
 Application: HAWTAI Motor 25



Drawing No.: 3407 0867 001

Controlled flow: 7.5L/min
 Fuel feed tube: $\phi 16$
 Fuel discharge hole: M16x1.5
 Displacement: 8.3ml/r
 Speed range: 5008000r/min
 Max pressure: 8MPa
 Rotation: R

Cross Ref.: 34071200A03
 Application: Santafe2.0

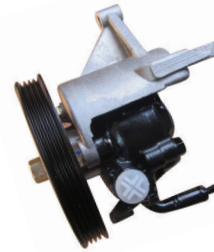

Drawing No.: 3407 1033 001

Controlled flow: 6.5L/min
 Fuel feed tube: $\phi 12$
 Fuel discharge hole: M16x1.5
 Displacement: 9.6ml/r
 Speed range: 5008000r/min
 Max pressure: 8MPa
 Rotation: R

Cross Ref.: 34070100E03
 Application: HAWTAI Motor T10



SORL No.: YBZ10C080/075
 Drawing No.: 3407 1003 001

Controlled flow: 8L/min
 Fuel feed tube: $\phi 15$
 Fuel discharge hole: M16x1.5
 Displacement: 9.6ml/r
 Speed range: 5007000r/min
 Max pressure: 7.5MPa
 Rotation: R

Cross Ref.: 5710026100
 Application: Santafe2.7



GEELY



SORL No.: YBZ10T065/080
 Drawing No.: 3407 1014 001

Controlled flow: 6.5L/min
 Fuel feed tube: $\phi 12$
 Fuel discharge hole: M16x1.5
 Displacement: 9.6ml/r
 Speed range: 5007000r/min
 Max pressure: 8MPa
 Rotation: R

Cross Ref.: TK-57110H1300
 Application: Terracan3.5



SORL No.: YBZ06055/055
 Drawing No.: 3407 0601 001

Controlled flow: 5.5L/min
 Fuel feed tube: $\phi 16$
 Fuel discharge hole: M16x1.5
 Displacement: 6ml/r
 Speed range: 5007000r/min
 Max pressure: 5.5MPa
 Rotation: R

Application: Geely



SORL No.: YBZ10T1065/080
 Drawing No.: 3407 1015 001

Controlled flow: 6.5L/min
 Fuel feed tube: $\phi 12$
 Fuel discharge hole: M16x1.5
 Displacement: 9.6ml/r
 Speed range: 5007000r/min
 Max pressure: 8MPa
 Rotation: R

Cross Ref.: TK-57110H1000
 Application: Terracan2.5



JAC



SORL No.: **YBZ10R075/080**
Drawing No.: **3407 1013 001**

Controlled flow: 7.5L/min
Fuel feed tube: $\phi 15$
Fuel discharge hole: M16x1.5
Displacement: 9.6ml/r
Speed range: 5007000r/min
Max pressure: 8MPa
Rotation: R

Application: JAC



Drawing No.: **3407 2147 001**

Controlled flow: 21L/min
Fuel feed hole: M26x1.5
Fuel discharge hole: M18x1.5
Displacement: 18ml/r
Speed range: 5003600r/min
Max pressure: 21MPa
Rotation: R

Cross Ref.: WG9725478037/2
ZF 7679 955 603



JINBEI



SORL No.: **YBZ21S160/130**
Drawing No.: **3407 2102 001**

Controlled flow: 16L/min
Fuel feed hole: M26x1.5
Fuel discharge hole: M18x1.5
Displacement: 21ml/r
Speed range: 5003900r/min
Max pressure: 13MPa
Rotation: R

Cross Ref.: WG9100130037



SORL No.: **YBZ08H075/085**
Drawing No.: **3407 0806 001**

Controlled flow: 7.5L/min
Fuel feed tube: $\phi 16$
Fuel discharge hole: M16x1.5
Displacement: 8.3ml/r
Speed range: 5007000r/min
Max pressure: 8.5MPa
Rotation: R

Cross Ref.: 3407010-06B
Application: HIACE



LIUZHOU WULIN



SINOTRUCK



Drawing No.: **3407 0717 001**

Controlled flow: 5.5L/min
Fuel feed hole: $\phi 16$
Fuel discharge hole: M16x1.5
Displacement: 7ml/r
Speed range: 5007000r/min
Max pressure: 5.8MPa
Rotation: R

Cross Ref.: 24519486
7079 955 207
Application: Liuzhou Wuling



Drawing No.: **3407 1712 001**

Controlled flow: 16.5L/min
Fuel feed hole: M26x1.5
Fuel discharge hole: M18x1.5
Displacement: 17ml/r
Speed range: 5003600r/min
Max pressure: 18MPa
Rotation: R

Cross Ref.: WG9619, 470080,
ZF 7684 955 198,
7684 955 121



NANHAI FOTON



Drawing No.: 3407 0839 001

Controlled flow: 7.5L/min
 Fuel feed tube: $\phi 16$
 Fuel discharge hole: M16x1.5
 Displacement: 8.3ml/r
 Speed range: 5008000r/min
 Max pressure: 8MPa
 Rotation: R

Cross Ref.: 1102734000370
 Application: NanHai Foton



Drawing No.: 3407 0840 001

Controlled flow: 7L/min
 Fuel feed tube: $\phi 16$
 Fuel discharge hole: M16x1.5
 Displacement: 8.3ml/r
 Speed range: 5008000r/min
 Max pressure: 8.5MPa
 Rotation: R

Cross Ref.: 1102734000373
 Application: NanHai Foton



Drawing No.: 3407 0860 001

Controlled flow: 8L/min
 Fuel feed tube: $\phi 16$
 Fuel discharge hole: M16x1.5
 Displacement: 8.3ml/r
 Speed range: 5008000r/min
 Max pressure: 8.5MPa
 Rotation: R

Cross Ref.: P0340030003A0
 Application: NanHai Foton



Drawing No.: 3407 0861 001

Controlled flow: 7L/min
 Fuel feed tube: $\phi 16$
 Fuel discharge hole: M16x1.5
 Displacement: 8.3ml/r
 Speed range: 5008000r/min
 Max pressure: 8.5MPa
 Rotation: R

Cross Ref.: 1102734000110
 Application: NanHai Foton



Drawing No.: 3407 1142 001

Controlled flow: 7.5L/min
 Fuel feed tube: $\phi 13.5$
 Fuel discharge hole: M16x1.5
 Displacement: 11ml/r
 Speed range: 5008000r/min
 Max pressure: 8MPa
 With reservoir
 Rotation: R

Cross Ref.: 1027A-3407100B
 Application: NanHai Foton



SORL No.: YBZ07065/055
 Drawing No.: 3407 0701 001

Controlled flow: 6.5L/min
 Fuel feed hole: $\phi 15$
 Fuel discharge hole: M16x1.5
 Displacement: 7ml/r
 Speed range: 5008000r/min
 Max pressure: 6MPa
 Rotation: R

Cross Ref.: S11-3407010
 Application: CHERY



SORL No.: YBZ07A065/055
 Drawing No.: 3407 0702 001

Controlled flow: 6.5L/min
 Fuel feed hole: $\phi 15$
 Fuel discharge hole: M16x1.5
 Displacement: 7ml/r
 Speed range: 5008000r/min
 Max pressure: 6MPa
 Rotation: R

Cross Ref.: S113407010BA
 Application: CHERY QQ



SORL No.: YBZ07A1067/075
 Drawing No.: 3407 0703 001

Controlled flow: 6.75L/min
 Fuel feed hole: $\phi 15$
 Fuel discharge hole: M16x1.5
 Displacement: 7ml/r
 Speed range: 5008000r/min
 Max pressure: 8.5MPa
 Rotation: R

Cross Ref.: S123407010
 Application: CHERY A1



SORL No.: YBZ07A2067/060
 Drawing No.: 3407 0704 001

Controlled flow: 6.75L/min
 Fuel feed hole: $\phi 15$
 Fuel discharge hole: M16x1.5
 Displacement: 7ml/r
 Speed range: 5008000r/min
 Max pressure: 6MPa
 Rotation: R

Cross Ref.: S123407010
 Application: CHERY



SORL No.: **YBZ07A4055/075**
Drawing No.: **3407 0705 001**

Controlled flow: 5.5L/min
Fuel feed hole: $\Phi 15$
Fuel discharge hole: M16x1.5
Displacement: 7ml/r
Speed range: 5008000r/min
Max pressure: 7.3MPa
Rotation: R

Cross Ref.: S223407010
Application: CHERY



SORL No.: **YBZ08Q2065/085**
Drawing No.: **3407 0825 001**

Controlled flow: 7.55L/min
Fuel feed hole: $\Phi 15$
Fuel discharge hole: M16x1.5
Displacement: 8ml/r
Speed range: 5008000r/min
Max pressure: 8.5MPa
Rotation: R

Cross Ref.: T11-3407010BB
Application: Chery



SORL No.: **YBZ07A5065/060**
Drawing No.: **3407 0706 001**

Controlled flow: 6.5L/min
Fuel feed hole: $\Phi 15$
Fuel discharge hole: M16x1.5
Displacement: 7ml/r
Speed range: 5008000r/min
Max pressure: 6MPa
Rotation: R

Cross Ref.: S123407010VB
Application: CHERY



SORL No.: **YBZ08Q3085/085**
Drawing No.: **3407 0826 001**

Controlled flow: 8.5L/min
Fuel feed hole: $\Phi 16$
Fuel discharge hole: M16x1.5
Displacement: 8.3ml/r
Speed range: 5008000r/min
Max pressure: 8.5MPa
Rotation: R

Cross Ref.: B113407010BA
Application: Chery



Drawing No.: **3407 0714 001**

Controlled flow: 7L/min
Fuel feed hole: $\Phi 16$
Fuel discharge hole: M16x1.5
Displacement: 7ml/r
Speed range: 5007000r/min
Max pressure: 9MPa
Rotation: R

Cross Ref.: A213407010HA
Application: Chery 477F



Drawing No.: **3407 0835 001**

Controlled flow: 7.55L/min
Fuel feed hole: $\Phi 15$
Fuel discharge hole: M16x1.5
Displacement: 8ml/r
Speed range: 5008000r/min
Max pressure: 8.5MPa
Rotation: R

Cross Ref.: T113407010BB
Application: Chery



SORL No.: **YBZ08Q-075/075**
Drawing No.: **3407 0823 001**

Controlled flow: 7.5L/min
Fuel feed hole: $\Phi 16$
Fuel discharge hole: M16x1.5
Displacement: 8.3ml/r
Speed range: 5008000r/min
Max pressure: 7.5MPa
Rotation: R

Cross Ref.: A11-3407020-4AK
Application: Chery



Drawing No.: **3407 0851 001**

Controlled flow: 7.5L/min
Fuel feed hole: $\Phi 16$
Fuel discharge hole: M16x1.5
Displacement: 8.3ml/r
Speed range: 5008000r/min
Max pressure: 8.5MPa
Rotation: R

Cross Ref.: T11-3407010BB
Application: Chery



SORL No.: **YBZ08Q1-065/075**
Drawing No.: **3407 0824 001**

Controlled flow: 6.5L/min
Fuel feed hole: $\Phi 15$
Fuel discharge hole: M16x1.5
Displacement: 8.3ml/r
Speed range: 5008000r/min
Max pressure: 7.5MPa
Rotation: R

Cross Ref.: S11-3407010
Application: Chery



SORL No.: **YBZ09Q085/085**
Drawing No.: **3407 0907 001**

Controlled flow: 8.5L/min
Fuel feed hole: $\Phi 16$
Fuel discharge hole: M16x1.5
Displacement: 9ml/r
Speed range: 5007000r/min
Max pressure: 8.5MPa
Rotation: R

Cross Ref.: A213407010
Application: Chery



Controlled flow: 8L/min
 Fuel feed hole: $\Phi 16$
 Fuel discharge hole: M16x1.5
 Displacement: 9.3ml/r
 Speed range: 4657000r/min
 Max pressure: 8.5MPa
 Rotation: R

SORL No.: **YBZ09Q1080/085**
 Drawing No.: **3407 0908 001**

Cross Ref.: M113407010
 Application: Chery



SHACMAN



Controlled flow: 7L/min
 Fuel feed hole: $\Phi 16$
 Fuel discharge hole: M16x1.5
 Displacement: 9.6ml/r
 Speed range: 5007000r/min
 Max pressure: 8MPa
 Rotation: R

SORL No.: **YBZ10Q070/080**
 Drawing No.: **3407 1010 001**

Cross Ref.: S113407010BB
 Application: Chery QQ



Controlled flow: 25L/min
 Fuel feed hole: M2x1.5
 Fuel discharge hole: M18x1.5
 Displacement: 21ml/r
 Speed range: 5003900r/min
 Max pressure: 15MPa
 Rotation: R

Drawing No.: **3407 2159 001**

Cross Ref.: DZ95319470500
 Application: Shanxi Auto



Controlled flow: 7L/min
 Fuel feed hole: $\Phi 16$
 Fuel discharge hole: M16x1.5
 Displacement: 11ml/r
 Speed range: 5007000r/min
 Max pressure: 8MPa
 Rotation: R

SORL No.: **YBZ11Q070/080**
 Drawing No.: **3407 1116 001**

Cross Ref.: S113407020
 Application: Chery QQ480



WUZHOU LONG



QUANCHAI



Controlled flow: 16L/min
 Fuel feed hole: M26x1.5
 Fuel discharge hole: M18x1.5
 Displacement: 14ml/r
 Rated speed : 1450r/min
 Max pressure: 13MPa
 Rotation: R

Drawing No.: **3407 1428 001**

Application: Zyd23-13CF01



Controlled flow: 10L/min
 Fuel feed hole: M24x1.5
 Fuel discharge hole: M16x1.5
 Displacement: 16ml/r
 Speed range: 5003600r/min
 Max pressure: 13MPa
 Rotation: L

Drawing No.: **3407 6603 001**

Application: QUANCHAI



SFC



Drawing No.: 3407 6604 001

Controlled flow: 12.5L/min
 Fuel feed hole: $\Phi 18$
 Fuel discharge hole: M20x1.5
 Displacement: 16ml/r
 Speed range: 5003600r/min
 Max pressure: 10.5MPa
 Rotation: L

Cross Ref.: 0363407010
 Application: SHIFENG QUAN-
 CHAIO490



Drawing No.: 3407 1683 001

Controlled flow: 18.9L/min
 Fuel feed hole: M27x1.5
 Fuel discharge hole: M18x1.5
 Displacement: 16.5ml/r
 Speed range: 5003200r/min
 Max pressure: 14MPa
 Rotation: R

Cross Ref.: 6996Y-TE10-3407010
 Application: KingLong YC6J



Drawing No.: 3407 1028 001

Controlled flow: 7L/min
 Fuel feed hole: $\Phi 16$
 Fuel discharge hole: M16x1.5
 Displacement: 9.6ml/r
 Speed range: 5008000r/min
 Max pressure: 10.5MPa
 Rotation: R

Cross Ref.: 0363407020
 Application: SHIFENG



Drawing No.: 3407 1693 001

Controlled flow: 20L/min
 Fuel feed hole: M30x1.5
 Fuel discharge hole: M20x1.5
 Displacement: 16ml/r
 Speed range: 5003200r/min
 Max pressure: 14MPa
 Rotation: R

Cross Ref.: XMQ6113-3407100/
 XMQ6113-3407110



Drawing No.: 3407 1140 001

Controlled flow: 10L/min
 Fuel feed hole: $\Phi 16$
 Fuel discharge hole: M16x1.5
 Displacement: 11ml/r
 Speed range: 5007000r/min
 Max pressure: 10.3MPa
 Rotation: R

Application: SHIFENG



Drawing No.: 3407 1694 001

Controlled flow: 20L/min
 Fuel feed hole: M30x1.5
 Fuel discharge hole: M20x1.5
 Displacement: 16ml/r
 Speed range: 5003200r/min
 Max pressure: 14MPa
 Rotation: L

Cross Ref.: XMQ6113-3407100L



KING LONG



Drawing No.: 3407 1695 001

Controlled flow: 20L/min
 Fuel feed hole: M30x1.5
 Fuel discharge hole: M20x1.5
 Displacement: 20.6ml/r
 Speed range: 5003200r/min
 Max pressure: 15MPa
 Rotation: L

Cross Ref.: XMQ6885B-3407100L



Drawing No.: 3407 1682 001

Controlled flow: 10L/min
 Fuel feed hole: M27x1.5
 Fuel discharge hole: M18x1.5
 Displacement: 16.6ml/r
 Speed range: 5003200r/min
 Max pressure: 10MPa
 Rotation: R

Cross Ref.: 6900Y-TF10-3407010
 Application: KingLong YC6J



Drawing No.: 3407 1727 001

Controlled flow: 16L/min
 Fuel feed hole: M27x1.5
 Fuel discharge hole: M18x1.5
 Displacement: 17ml/r
 Speed range: 5004000r/min
 Max pressure: 18MPa
 Rotation: R

Cross Ref.:
 6140YSWD803407100



Controlled flow: 8.75L/min
 Fuel feed hole: M27x1.5
 Fuel discharge hole: M18x1.5
 Displacement: 16ml/r
 Speed range: 5003600r/min
 Max pressure: 10MPa
 Rotation: L

Cross Ref.: XMQ6830E-3407100
 Application: YC4112ZLQ/
 YC4110ZLQ

Drawing No.: 3407 1739 001



Controlled flow: 9L/min
 Fuel feed hole: M18x1.5
 Fuel discharge hole: M16x1.5
 Displacement: 14.5ml/r
 Speed range: 5003200r/min
 Max pressure: 10MPa
 Rotation: L

Cross Ref.: 3407020-B41-HQ4AR
 Application: XiChai

Drawing No.: 3407 1440 001



Controlled flow: 14L/min
 Fuel feed hole: M27x1.5
 Fuel discharge hole: M18x1.5
 Displacement: 16.6ml/r
 Speed range: 5003600r/min
 Max pressure: 14MPa
 Rotation: L

Cross Ref.: 23450014
 Application: XiaMen KingLong

Drawing No.: 3407 6666 001



Controlled flow: 19L/min
 Fuel feed hole: M18x1.5
 Fuel discharge hole: M18x1.5
 Displacement: 16.7ml/r
 Speed range: 5003200r/min
 Max pressure: 14MPa
 Rotation: L

Cross Ref.: 3407020B29D/
 3407020C600-0367
 Application: XiChai

SORL No.: YBZ16C2B190/140L
 Drawing No.: 3407 1620 001



Controlled flow: 12L/min
 Fuel feed hole: M27x1.5
 Fuel discharge hole: M18x1.5
 Displacement: 16ml/r
 Speed range: 5003600r/min
 Max pressure: 14MPa
 Rotation: L

Cross Ref.: 234500026
 Application: XiaMen KingLong

Drawing No.: 3407 6680 001



Controlled flow: 13L/min
 Fuel feed hole: ϕ 18.5
 Fuel discharge hole: M18x1.5
 Displacement: 16ml/r
 Speed range: 5003200r/min
 Max pressure: 10.5MPa
 Rotation: L

Cross Ref.: 3407020-CA01KM1A
 Application: XiChai

SORL No.: YBZ16D7E130/105L
 Drawing No.: 3407 1640 001



XICHAO



Controlled flow: 11L/min
 Fuel feed hole: ϕ 18.5
 Fuel discharge hole: M20x1.5
 Displacement: 16.7ml/r
 Speed range: 5003200r/min
 Max pressure: 11MPa
 Rotation: L

Cross Ref.: 3407020-A02YK1AR
 Application: XiChai

SORL No.: YBZ16D7F110/110L
 Drawing No.: 3407 1641 001



Controlled flow: 11L/min
 Fuel feed hole: M18x1.5
 Fuel discharge hole: M16x1.5
 Displacement: 14ml/r
 Speed range: 5004000r/min
 Max pressure: 13MPa
 Rotation: L

Cross Ref.: 3407020A032010
 Application: XiChai

SORL No.: YBZ14K110/130L
 Drawing No.: 3407 1414 001



Controlled flow: 13L/min
 Fuel feed hole: M18x1.5
 Fuel discharge hole: M18x1.5
 Displacement: 16.7ml/r
 Speed range: 5003200r/min
 Max pressure: 10.5MPa
 Rotation: L

Cross Ref.: 3407020-AA05305A
 Application: XiChai6108A3000

SORL No.: YBZ16D7H130/105L
 Drawing No.: 3407 1642 001



SORL No.: **YBZ16E-190/130LL**
Drawing No.: **3407 1643 001**

Controlled flow: 19L/min
Fuel feed hole: M24x1.5
Fuel discharge hole: M18x1.5
Displacement: 16.7ml/r
Speed range: 5003200r/min
Max pressure: 13MPa
Rotation: L

Cross Ref.: 3407020-202-3510
Application: XiChai



Drawing No.: **3407 1665 001**

Controlled flow: 13L/min
Fuel feed hole: M24x1.5
Fuel discharge hole: M20x1.5
Displacement: 16ml/r
Speed range: 5003200r/min
Max pressure: 10.5MPa
Rotation: L

Cross Ref.: 3407020A20LQ1AR
Application: XiChai



Drawing No.: **3407 1661 001**

Controlled flow: 13L/min
Fuel feed hole: M20x1.5
Fuel discharge hole: M20x1.5
Displacement: 16.7ml/r
Speed range: 5003200r/min
Max pressure: 13MPa
Rotation: L

Cross Ref.: 3407020-A01CS1AR
Application: XiChai



Drawing No.: **3407 1676 001**

Controlled flow: 10L/min
Fuel feed hole: ϕ 15
Fuel discharge hole: M16x1.5
Displacement: 16ml/r
Speed range: 5003200r/min
Max pressure: 10MPa
Rotation: L

Cross Ref.: 3407020B61501A
Application: XiChai



Drawing No.: **3407 1662 001**

Controlled flow: 13L/min
Fuel feed hole: ϕ 18.5
Fuel discharge hole: M20x1.5
Displacement: 16ml/r
Speed range: 5003200r/min
Max pressure: 10.5MPa
Rotation: L

Cross Ref.: 3407020-A01-KM1A
Application: XiChai



Drawing No.: **3407 1677 001**

Controlled flow: 10L/min
Fuel feed hole: ϕ 16
Fuel discharge hole: M16x1.5
Displacement: 16ml/r
Speed range: 5003200r/min
Max pressure: 10MPa
Rotation: L

Cross Ref.: 3407020AB71HT1A
Application: XiChai



Drawing No.: **3407 1663 001**

Controlled flow: 11L/min
Fuel feed hole: ϕ 16
Fuel discharge hole: M20x1.5
Displacement: 16ml/r
Speed range: 5003200r/min
Max pressure: 11MPa
Rotation: L

Cross Ref.: 3407020AA02-HG1AR
Application: XiChai



Drawing No.: **3407 1678 001**

Controlled flow: 11L/min
Fuel feed hole: ϕ 16
Fuel discharge hole: M16x1.5
Displacement: 16ml/r
Speed range: 5003200r/min
Max pressure: 11MPa
Rotation: L

Cross Ref.: 3407020A05HT1A
3407020A065020
Application: XiChai



Drawing No.: **3407 1664 001**

Controlled flow: 13L/min
Fuel feed hole: ϕ 18.5
Fuel discharge hole: M20x1.5
Displacement: 16ml/r
Speed range: 5003200r/min
Max pressure: 10.5MPa
Rotation: L

Cross Ref.: 3407020A02ZY1AR
Application: XiChai



Drawing No.: **3407 1680 001**

Controlled flow: 10L/min
Fuel feed hole: ϕ 15
Fuel discharge hole: M16x1.5
Displacement: 16ml/r
Speed range: 5003200r/min
Max pressure: 10MPa
Rotation: L

Cross Ref.: 3407020B46HT3A
Application: XiChai



Drawing No.: 3407 1681 001

Controlled flow: 11L/min
 Fuel feed hole: $\Phi 16$
 Fuel discharge hole: M16x1.5
 Displacement: 16ml/r
 Speed range: 5003200r/min
 Max pressure: 11MPa
 Rotation: L

Cross Ref.: 3407020A36HT1AF
 Application: XiChai



Drawing No.: 3407 1819 001

Controlled flow: 16L/min
 Fuel feed hole: $\Phi 24$
 Fuel discharge hole: M18x1.5
 Displacement: 18.4ml/r
 Speed range: 6003200r/min
 Max pressure: 16MPa
 Rotation: L

Cross Ref.: 3407020-M01-C00
 Application: XiChai



Drawing No.: 3407 1743 001

Controlled flow: 12L/min
 Fuel feed hole: M27x1.5
 Fuel discharge hole: M20x1.5
 Displacement: 16.6ml/r
 Speed range: 5003200r/min
 Max pressure: 13MPa
 Rotation: L

Cross Ref.: 3407020-A06-CS3AR
 Application: XiChai



Drawing No.: 3407 1820 001

Controlled flow: 16L/min
 Fuel feed hole: $\Phi 24$
 Fuel discharge hole: M18x1.5
 Displacement: 18.4ml/r
 Speed range: 6003200r/min
 Max pressure: 15MPa
 Rotation: L

Cross Ref.: 3407020-851-C01
 Application: XiChai



Drawing No.: 3407 1811 001

Controlled flow: 16L/min
 Fuel feed hole: $\Phi 24$
 Fuel discharge hole: M18x1.5
 Displacement: 18.4ml/r
 Speed range: 6003200r/min
 Max pressure: 15MPa
 Rotation: L

Cross Ref.: 3407020-795-C00
 Application: XiChai



Drawing No.: 3407 1825 001

Controlled flow: 16L/min
 Fuel feed hole: $\Phi 24$
 Fuel discharge hole: M18x1.5
 Displacement: 18ml/r
 Speed range: 5003200r/min
 Max pressure: 18MPa
 Rotation: R

Cross Ref.: 3407020-M11-0896
 Application: XiChai



Drawing No.: 3407 1815 001

Controlled flow: 16L/min
 Fuel feed hole: $\Phi 24$
 Fuel discharge hole: M18x1.5
 Displacement: 18.4ml/r
 Speed range: 6003200r/min
 Max pressure: 15MPa
 Rotation: L

Cross Ref.: 3407020-911-C00
 Application: XiChai



Drawing No.: 3407 1826 001

Controlled flow: 16L/min
 Fuel feed hole: $\Phi 24$
 Fuel discharge hole: M18x1.5
 Displacement: 18.4ml/r
 Speed range: 6003200r/min
 Max pressure: 15MPa
 Rotation: L

Cross Ref.: 3407020-65V-0K05
 Application: XiChai



Drawing No.: 3407 1817 001

Controlled flow: 16L/min
 Fuel feed hole: $\Phi 24$
 Fuel discharge hole: M18x1.5
 Displacement: 18.4ml/r
 Speed range: 6003200r/min
 Max pressure: 16MPa
 Rotation: L

Cross Ref.: 3407020-624-SJ10E
 Application: XiChai FZB02G2



Drawing No.: 3407 6606 001

Controlled flow: 10L/min
 Fuel feed hole: $\Phi 16$
 Fuel discharge hole: M20x1.5
 Displacement: 16.6ml/r
 Speed range: 5003200r/min
 Max pressure: 10MPa
 Rotation: L

Cross Ref.: 3407020AB46-WZ1AR
 Application: XiChai

Pictures And/Or OEM Part Numbers are for reference purpose only.



Controlled flow: 13L/min
 Fuel feed hole: $\Phi 21.5$
 Fuel discharge hole: M18x1.5
 Displacement: 16.7ml/r
 Speed range: 5003200r/min
 Max pressure: 10.5MPa
 Rotation: L

Drawing No.: 3407 6607 001

Cross Ref.: 3407020-A01-KM1A
 Application: XiChai



Controlled flow: 9L/min
 Fuel feed hole: $\Phi 18.5$
 Fuel discharge hole: M16x1.5
 Displacement: 16.6ml/r
 Speed range: 5003200r/min
 Max pressure: 11MPa
 Rotation: L

Drawing No.: 3407 6615 001

Cross Ref.: 3407020AB41-JB2AR
 Application: XiChai



Controlled flow: 10L/min
 Fuel feed hole: $\Phi 21.5$
 Fuel discharge hole: M20x1.5
 Displacement: 16.6ml/r
 Speed range: 5003200r/min
 Max pressure: 10MPa
 Rotation: L

Drawing No.: 3407 6611 001

Cross Ref.: 3407020-B46-SS1AR
 Application: XiChai



Controlled flow: 10L/min
 Fuel feed hole: $\Phi 16$
 Fuel discharge hole: M16x1.5
 Displacement: 16.6ml/r
 Speed range: 5003200r/min
 Max pressure: 10MPa
 Rotation: L

Drawing No.: 3407 6616 001

Cross Ref.: 3407020-B46-ZC1AR
 Application: XiChai



Controlled flow: 10L/min
 Fuel feed hole: $\Phi 21.5$
 Fuel discharge hole: M20x1.5
 Displacement: 16.6ml/r
 Speed range: 5003200r/min
 Max pressure: 13MPa
 Rotation: L

Drawing No.: 3407 6612 001

Cross Ref.: 3407020AB46-ZY1AR
 Application: XiChai



Controlled flow: 13L/min
 Fuel feed hole: $\Phi 22$
 Fuel discharge hole: M18x1.5
 Displacement: 16.8ml/r
 Speed range: 5003200r/min
 Max pressure: 10.5MPa
 Rotation: L

Drawing No.: 3407 6618 001

Cross Ref.: 3407020-A3B-DK1AR
 Application: XiChai



Controlled flow: 10L/min
 Fuel feed hole: $\Phi 16$
 Fuel discharge hole: M16x1.5
 Displacement: 16.6ml/r
 Speed range: 5003200r/min
 Max pressure: 10MPa
 Rotation: L

Drawing No.: 3407 6613 001

Cross Ref.: 3407020-B46-ZC1ATR
 Application: XiChai



Controlled flow: 13L/min
 Fuel feed hole: $\Phi 18$
 Fuel discharge hole: M20x1.5
 Displacement: 16.7ml/r
 Speed range: 5003200r/min
 Max pressure: 10.5MPa
 Rotation: L

Drawing No.: 3407 6619 001

Cross Ref.: 3407020-A05-SF1AR
 Application: XiChai



Controlled flow: 8L/min
 Fuel feed hole: $\Phi 16$
 Fuel discharge hole: M18x1.5
 Displacement: 16.6ml/r
 Speed range: 5003200r/min
 Max pressure: 12MPa
 Rotation: L

Drawing No.: 3407 6614 001

Cross Ref.: 3407020AB41-JB1AR
 Application: XiChai



Controlled flow: 10L/min
 Fuel feed hole: $\Phi 16$
 Fuel discharge hole: M16x1.5
 Displacement: 16.6ml/r
 Speed range: 5003200r/min
 Max pressure: 10MPa
 Rotation: L

Drawing No.: 3407 6623 001

Cross Ref.: 3407020AB46-ZC1CR
 Application: XiChai

Pictures And/Or OEM Part Numbers are for reference purpose only.



Controlled flow: 13L/min
 Fuel feed hole: $\Phi 19$
 Fuel discharge hole: M18x1.5
 Displacement: 16.7ml/r
 Speed range: 5003200r/min
 Max pressure: 10.5MPa
 Rotation: L

Drawing No.: 3407 6646 001

Cross Ref.: 3407020-A71-KM1AR
 Application: XiChai



Controlled flow: 22L/min
 Fuel feed hole: M24x1.5
 Fuel discharge hole: M18x1.5
 Displacement: 22ml/r
 Speed range: 5003600r/min
 Max pressure: 15MPa
 Rotation: L

Drawing No.: 3407 2207 001

Cross Ref.: 34070204203055
 Application: XiChai



Controlled flow: 10L/min
 Fuel feed hole: $\Phi 21.5$
 Fuel discharge hole: M18x1.5
 Displacement: 16.6ml/r
 Speed range: 5003200r/min
 Max pressure: 10MPa
 Rotation: L

Drawing No.: 3407 6651 001

Cross Ref.: 3407020-B46-KM5CR
 Application: XiChai



Controlled flow: 25L/min
 Fuel feed hole: $\Phi 25$
 Fuel discharge hole: M18x1.5
 Displacement: 22ml/r
 Speed range: 5003200r/min
 Max pressure: 13MPa
 Rotation: L

Drawing No.: 3407 2211 001

Cross Ref.: 3407020-420-3055
 Application: XiChai



Controlled flow: 12L/min
 Fuel feed hole: M27x1.5
 Fuel discharge hole: M18x1.5
 Displacement: 16.6ml/r
 Speed range: 5003200r/min
 Max pressure: 13MPa
 Rotation: L

Drawing No.: 3407 6652 001

Cross Ref.: 3407020AA06-KM10R
 Application: XiChai



WEI CHAI



Controlled flow: 13L/min
 Fuel feed hole: $\Phi 19$
 Fuel discharge hole: M18x1.5
 Displacement: 16.7ml/r
 Speed range: 5003200r/min
 Max pressure: 10.5MPa
 Rotation: L

Drawing No.: 3407 6654 001

Cross Ref.: 3407020BA71-KM1AR
 Application: XiChai



Controlled flow: 7.5L/min
 Fuel feed hole: $\Phi 15$
 Fuel discharge hole: M16x1.5
 Displacement: 8ml/r
 Speed range: 5007000r/min
 Max pressure: 8.5MPa
 Rotation: R

SORL No.: YBZ08H1-075/085
 Drawing No.: 3407 0807 001

Cross Ref.: YZ485ZLQ02059
 Application: WeiChai485



Controlled flow: 22L/min
 Fuel feed hole: $\Phi 22$
 Fuel discharge hole: M24x1.5
 Displacement: 22ml/r
 Speed range: 5003600r/min
 Max pressure: 15MPa
 Rotation: L

Drawing No.: 3407 2205 001

Cross Ref.: 3407020A116B1
 Application: XiChai



Controlled flow: 7L/min
 Fuel feed hole: $\Phi 15$
 Fuel discharge hole: M16x1.5
 Displacement: 10ml/r
 Speed range: 5007000r/min
 Max pressure: 10MPa
 Rotation: R

SORL No.: YBZ10Q1-070/100
 Drawing No.: 3407 1011 001

Cross Ref.: YBZ10Q1002
 Application: WeiChai

Pictures And/Or OEM Part Numbers are for reference purpose only.



Controlled flow: 8L/min
 Fuel feed hole: $\Phi 15$
 Fuel discharge hole: M16x1.5
 Displacement: 11ml/r
 Speed range: 5004000r/min
 Max pressure: 10MPa
 Rotation: R

Cross Ref.: YBZ10Q1002
 YZ485ZLQ-02059B
 Application: WeiChai NJ1020

SORL No.: **YBZ10Q1002**
 Drawing No.: **3407 1122 001**



Controlled flow: 14L/min
 Fuel feed hole: $\Phi 18$
 Fuel discharge hole: 3/4-16UNF
 Displacement: 16ml/r
 Speed range: 5003200r/min
 Max pressure: 10.5MPa
 Rotation: L

Cross Ref.: YZ4102ZLQ02059C
 Application: WeiChai

SORL No.: **YBZ16D7D-140/105L**
 Drawing No.: **3407 1639 001**



Controlled flow: 10L/min
 Fuel feed hole: $\Phi 18$
 Fuel discharge hole: 3/4-16UNF
 Displacement: 16ml/r
 Speed range: 5003200r/min
 Max pressure: 10.5MPa
 Rotation: L

Cross Ref.: YZ4DE202059
 Application: WeiChai

SORL No.: **YBZ16D2A-100/105L**
 Drawing No.: **3407 1628 001**



Controlled flow: 8L/min
 Fuel feed hole: $\Phi 16$
 Fuel discharge hole: M16x1.5
 Displacement: 16ml/r
 Speed range: 5003600r/min
 Max pressure: 10.5MPa
 Rotation: R

Cross Ref.: YBZ216N002
 Application: WeiChai

SORL No.: **YBZ16N-080/105**
 Drawing No.: **3407 1645 001**



Controlled flow: 10L/min
 Fuel feed hole: $\Phi 18$
 Fuel discharge hole: 3/4-16UNF
 Displacement: 16ml/r
 Speed range: 5003200r/min
 Max pressure: 10.5MPa
 Rotation: L

Cross Ref.: YZ4D37TC02059
 Application: WeiChai

SORL No.: **YBZ16D2B-100/105L**
 Drawing No.: **3407 1629 001**



Controlled flow: 8L/min
 Fuel feed hole: $\Phi 18$
 Fuel discharge hole: 3/4-16UNF
 Displacement: 16ml/r
 Speed range: 5003600r/min
 Max pressure: 10.5MPa
 Rotation: R

Cross Ref.: YBZ216N1002
 Application: WeiChai

SORL No.: **YBZ16N1-080/105**
 Drawing No.: **3407 1646 001**



Controlled flow: 10L/min
 Fuel feed hole: $\Phi 18$
 Fuel discharge hole: 3/4-16UNF
 Displacement: 16ml/r
 Speed range: 5003200r/min
 Max pressure: 10.5MPa
 Rotation: L

Cross Ref.: YZ4102ZLQ02059
 Application: WeiChai 4102

SORL No.: **YBZ16D7-100/105L**
 Drawing No.: **3407 1635 001**



Controlled flow: 10L/min
 Fuel feed hole: M20x1.5
 Fuel discharge hole: M16x1.5
 Displacement: 16ml/r
 Speed range: 5003600r/min
 Max pressure: 13MPa
 Rotation: R

Cross Ref.: YBZ216N004
 Application: WeiChai

SORL No.: **YBZ16N2-100/130**
 Drawing No.: **3407 1647 001**



Controlled flow: 10L/min
 Fuel feed hole: $\Phi 22$
 Fuel discharge hole: M18x1.5
 Displacement: 16ml/r
 Speed range: 5003200r/min
 Max pressure: 10.5MPa
 Rotation: L

Cross Ref.: YZ4102ZLQ02059A
 Application: WeiChai 4102

SORL No.: **YBZ16D7B-100/105L**
 Drawing No.: **3407 1637 001**



Controlled flow: 10L/min
 Fuel feed hole: M24x1.5
 Fuel discharge hole: M16x1.5
 Displacement: 16ml/r
 Speed range: 5003600r/min
 Max pressure: 13MPa
 Rotation: L

Cross Ref.: YBZ216N006
 Application: WeiChai

SORL No.: **YBZ16N3-100/130L**
 Drawing No.: **3407 1648 001**

Pictures And/Or OEM Part Numbers are for reference purpose only.



SORL No.: **YBZ16N4-100/120**
Drawing No.: **3407 1649 001**

Controlled flow: 10L/min
Fuel feed hole: $\phi 16$
Fuel discharge hole: M16x1.5
Displacement: 16ml/r
Speed range: 5003600r/min
Max pressure: 12MPa
Rotation: R

Cross Ref.: YBZ216N007
Application: WeiChai



SORL No.: **YBZ16D2100/130L**
Drawing No.: **3407 1660 001**

Controlled flow: 10L/min
Fuel feed hole: M24x2
Fuel discharge hole: M20x1.5
Displacement: 16ml/r
Speed range: 5003200r/min
Max pressure: 13MPa
Rotation: L

Cross Ref.: YZ4108Q-02059C
Application: WeiChai



SORL No.: **YBZ16N5-100/100L**
Drawing No.: **3407 1650 001**

Controlled flow: 10L/min
Fuel feed hole: M20x1.5
Fuel discharge hole: M16x1.5
Displacement: 16ml/r
Speed range: 5003600r/min
Max pressure: 10MPa
Rotation: L

Cross Ref.: YBZ216N008
Application: WeiChai



Drawing No.: **3407 1692 001**

Controlled flow: 8L/min
Fuel feed hole: M20x1.5
Fuel discharge hole: M16x1.5
Displacement: 16ml/r
Speed range: 5003600r/min
Max pressure: 10.5MPa
Rotation: R

Cross Ref.: YBZ216N1-002A
Application: WeiChai



SORL No.: **YBZ16N6120/130**
Drawing No.: **3407 1651 001**

Controlled flow: 12L/min
Fuel feed hole: $\phi 16$
Fuel discharge hole: M16x1.5
Displacement: 16ml/r
Speed range: 5003600r/min
Max pressure: 13MPa
Rotation: R

Cross Ref.: YBZ216N009
Application: WeiChai



Drawing No.: **3407 1697 001**

Controlled flow: 10L/min
Fuel feed hole: $\phi 18$
Fuel discharge hole: -16UNF
Displacement: 16ml/r
Speed range: 5003200r/min
Max pressure: 10.5MPa
Rotation: L

Cross Ref.: YZ4102ZLQ-02059D
Application: WeiChai



SORL No.: **YBZ16N7100/105L**
Drawing No.: **3407 1652 001**

Controlled flow: 10L/min
Fuel feed hole: $\phi 16$
Fuel discharge hole: M16x1.5
Displacement: 16ml/r
Speed range: 5003600r/min
Max pressure: 10.5MPa
Rotation: L

Cross Ref.: YZ4DE1-02059
Application: WeiChai



Drawing No.: **3407 6621 001**

Controlled flow: 10L/min
Fuel feed hole: $\phi 18$
Fuel discharge hole: M16x1.5
Displacement: 16ml/r
Speed range: 5003600r/min
Max pressure: 9MPa
Rotation: L

Cross Ref.: YBZ216N-013
Application: WeiChai

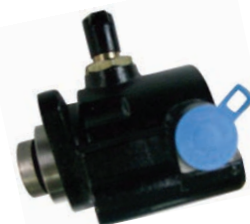

SORL No.: **YBZ16D2100/105L**
Drawing No.: **3407 1659 001**

Controlled flow: 10L/min
Fuel feed hole: $\phi 18$
Fuel discharge hole: M20x1.5
Displacement: 16ml/r
Speed range: 5003200r/min
Max pressure: 10.5MPa
Rotation: L

Cross Ref.: YZ4108Q-02059B
Application: WeiChai



Drawing No.: **3407 6624 001**

Controlled flow: 10L/min
Fuel feed hole: $\phi 16$
Fuel discharge hole: M16x1.5
Displacement: 16ml/r
Speed range: 5003600r/min
Max pressure: 9MPa
Rotation: R

Cross Ref.: YBZ216N-015
Application: WeiChai



Controlled flow: 9L/min
 Fuel feed hole: $\Phi 16$
 Fuel discharge hole: M18x1.5
 Displacement: 16.6ml/r
 Speed range: 5003200r/min
 Max pressure: 10MPa
 Rotation: L

Drawing No.: 3407 6629 001

Cross Ref.: YBZ216Q5A-003
 Application: WeiChai



Controlled flow: 6.5L/min
 Fuel feed hole: $\Phi 16$
 Fuel discharge hole: M16x1.5
 Displacement: 9ml/r
 Speed range: 5007000r/min
 Max pressure: 8MPa
 Rotation: R

SORL No.: YBZ09D065/080
 Drawing No.: 3407 0904 001

Cross Ref.: YZ480-80223100
 YD480ZL-802-23100
 Application: YangDong



Controlled flow: 10L/min
 Fuel feed hole: M24x1.5
 Fuel discharge hole: M16x1.5
 Displacement: 16.6ml/r
 Speed range: 500-3600r/min
 Max pressure: 13MPa
 Rotation: L

Drawing No.: 3407 6631 001

Application: WeiChai



Controlled flow: 9.5L/min
 Fuel feed hole: $\Phi 15$
 Fuel discharge hole: M16x1.5
 Displacement: 10ml/r
 Speed range: 5007000r/min
 Max pressure: 10MPa
 Rotation: R

SORL No.: YBZ10Q2095/100
 Drawing No.: 3407 1012 001

Cross Ref.: A230 1000 007
 Application: YND 485ZL engine



Controlled flow: 10L/min
 Fuel feed hole: M27x1.5
 Fuel discharge hole: M18x1.5
 Displacement: 16.6ml/r
 Speed range: 5003600r/min
 Max pressure: 13MPa
 Rotation: L

Drawing No.: 3407 6645 001

Cross Ref.: YBZ216N-023
 Application: WeiChai



Controlled flow: 11L/min
 Fuel feed hole: $\Phi 15$
 Fuel discharge hole: M16x1.5
 Displacement: 12ml/r
 Speed range: 5007500r/min
 Max pressure: 9MPa
 Rotation: R

SORL No.: YBZ12Q110/090
 Drawing No.: 3407 1204 001

Cross Ref.: B23001000009
 Application: YangDong



Controlled flow: 10L/min
 Fuel feed hole: $\Phi 12$
 Fuel discharge hole: M16x1.5
 Displacement: 16ml/r
 Speed range: 5003600r/min
 Max pressure: 13MPa
 Rotation: L

Drawing No.: 3407 6664 001

Cross Ref.: YBZ216N-025
 Application: WeiChai





Controlled flow: 11L/min
 Fuel feed hole: M27x1.5
 Fuel discharge hole: M16x1.5
 Displacement: 12ml/r
 Speed range: 5003200r/min
 Max pressure: 10MPa
 Rotation: L

Drawing No.: 3407 1205 001

Cross Ref.: D0110-3407100C
 Application: Yuchai



Drawing No.: 3407 1666 001

Controlled flow: 11L/min
 Fuel feed hole: M27x1.5
 Fuel discharge hole: M16x1.5
 Displacement: 16ml/r
 Speed range: 5003600r/min
 Max pressure: 13MPa
 Rotation: L

Cross Ref.: E0208-3407100
 Application: Yuchai



SORL No.: YBZ16K1200/140L
 Drawing No.: 3407 1722 001

Controlled flow: 20L/min
 Fuel feed hole: M27x1.5
 Fuel discharge hole: M20x1.5
 Displacement: 16ml/r
 Speed range: 5003600r/min
 Max pressure: 10MPa
 Rotation: L

Cross Ref.: 370H3400000
 Application: Yuchai 6108ZQB



SORL No.: YBZ16C3200/140
 Drawing No.: 3407 1621 001

Controlled flow: 20L/min
 Fuel feed hole: M30x2
 Fuel discharge hole: M20x1.5
 Displacement: 16ml/r
 Speed range: 5007000r/min
 Max pressure: 14MPa
 Rotation: R

Cross Ref.: 151-3407010
 Application: Yuchai / CUMMINS

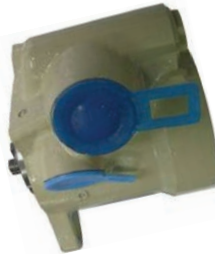

Drawing No.: 3407 2213 001

Controlled flow: 23L/min
 Fuel feed hole: M27x1.5
 Fuel discharge hole: M20x1.5
 Displacement: 22ml/r
 Speed range: 5003200r/min
 Max pressure: 14MPa
 Rotation: R

Cross Ref.: A44D23407100
 Application: Yuchai



SORL No.: YB16K150/100L
 Drawing No.: 3407 1719 001

Controlled flow: 15L/min
 Fuel feed hole: M27x1.5
 Fuel discharge hole: M16x1.5
 Displacement: 16ml/r
 Speed range: 5003600r/min
 Max pressure: 10MPa
 Rotation: L

Cross Ref.: 645-3400000
 Application: Yuchai 6105engine



SORL No.: YBZ16K200/140L
 Drawing No.: 3407 1720 001

Controlled flow: 20L/min
 Fuel feed hole: M27x1.5
 Fuel discharge hole: M16x1.5
 Displacement: 16ml/r
 Speed range: 5003600r/min
 Max pressure: 14MPa
 Rotation: L

Cross Ref.: 430A3400010A/B
 Application: Yuchai 6108ZQB



Drawing No.: 3407 1684 001

Controlled flow: 12L/min
 Fuel feed hole: M27x1.5
 Fuel discharge hole: M18x1.5
 Displacement: 16ml/r
 Speed range: 5003600r/min
 Max pressure: 13MPa
 Rotation: R

Cross Ref.: 3231
 Application: Yunan LIFAN



SORL No.: YBZ16K1150/100L
 Drawing No.: 3407 1721 001

Controlled flow: 20L/min
 Fuel feed hole: M27x1.5
 Fuel discharge hole: M20x1.5
 Displacement: 16ml/r
 Speed range: 5003600r/min
 Max pressure: 10MPa
 Rotation: L

Cross Ref.: 670A3407010
 Application: Yuchai 6105



Drawing No.: 3407 2146 001

Controlled flow: 20L/min
 Fuel feed hole: M26x1.5
 Fuel discharge hole: M18x1.5
 Displacement: 21ml/r
 Speed range: 5003200r/min
 Max pressure: 14MPa
 Rotation: R

Application: WP4,WP6



Drawing No.: 3407 0838 001

Controlled flow: 9L/min
 Fuel feed hole: $\Phi 16$
 Fuel discharge hole: M16x1.5
 Displacement: 8ml/r
 Speed range: 5007000r/min
 Max pressure: 10MPa
 Rotation: R

Application: Yunan LIFAN



ZHUCHENG FOTON



YUNNEI



Drawing No.: 3407 1541 001

Controlled flow: 13L/min
 Fuel feed hole: M27x1.5
 Fuel discharge hole: M16x1.5
 Displacement: 16.8ml/r
 Speed range: 5003200r/min
 Max pressure: 13MPa
 Rotation: L

Cross Ref.: D0710-3407100(G0340030034A0)
 Application: ZhuCheng Foton



Drawing No.: 3407 0837 001

Controlled flow: 7.5L/min
 Fuel feed hole: $\Phi 16$
 Fuel discharge hole: M16x1.5
 Displacement: 8ml/r
 Speed range: 5008000r/min
 Max pressure: 7.5MPa
 Rotation: R

Cross Ref.: CC1021SM-3407120A
 Application: YN4100QBZL

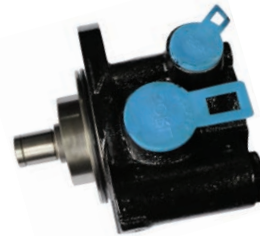

Drawing No.: 3407 1542 001

Controlled flow: 11L/min
 Fuel feed hole: M27x1.5
 Fuel discharge hole: M16x1.5
 Displacement: 16.8ml/r
 Speed range: 50032600r/min
 Max pressure: 13MPa
 Rotation: L

Cross Ref.: E0208-3407100A
 Application: ZhuCheng Foton



ZXAUTO



SORL No.: YBZ16P1-100/090L
 Drawing No.: 3407 1653 001

Controlled flow: 10L/min
 Fuel feed hole: $\Phi 18$
 Fuel discharge hole: M16x1.5
 Displacement: 16ml/r
 Speed range: 5003200r/min
 Max pressure: 9MPa
 Rotation: L
 Cross Ref.: 1106934000058,
 1108934000046
 Application: ZhuCheng Foton
 BJ1069VCJFA-A



SORL No.: YBZ08Z075/080
 Drawing No.: 3407 0831 001

Controlled flow: 7.5L/min
 Fuel feed hole: $\Phi 16$
 Fuel discharge hole: M16x1.5
 Displacement: 8ml/r
 Speed range: 5007000r/min
 Max pressure: 8MPa
 Rotation: R

Cross Ref.: 853/1027AZF33407010
 Application: ZTE pickup



SORL No.: YBZ16P-100/090
 Drawing No.: 3407 1654 001

Controlled flow: 10L/min
 Fuel feed hole: M22x1.5
 Fuel discharge hole: M16x1.5
 Displacement: 16ml/r
 Speed range: 5003600r/min
 Max pressure: 9MPa
 Rotation: R

Cross Ref.: 1104334000043
 Application: ZhuCheng Foton



SORL No.: **YBZ16S-160/130**
Drawing No.: **3407 1656 001**

Controlled flow: 16L/min
Fuel feed hole: M26x1.5
Fuel discharge hole: M18x1.5
Displacement: 16ml/r
Speed range: 5003900r/min
Max pressure: 13MPa
Rotation: R

Cross Ref.: 13186340X0053
Application: ZhuCheng Foton



Drawing No.: **3407 2154 001**

Controlled flow: 19.5L/min
Fuel feed hole: M27x1.5
Fuel discharge hole: M16x1.5
Displacement: 20ml/r
Speed range: 5003200r/min
Max pressure: 13.5MPa
Rotation: L

Cross Ref.: 3430-3407100
Application: ZhuCheng Foton



Drawing No.: **3407 1723 001**

Controlled flow: 14L/min
Fuel feed hole: M27x1.5
Fuel discharge hole: M18x1.5
Displacement: 17.5ml/r
Speed range: 5003900r/min
Max pressure: 16MPa
Rotation: R

Cross Ref.: 1318634000026
Application: ZhuCheng Foton
3P49PE265(A1)



Drawing No.: **3407 2155 001**

Controlled flow: 20L/min
Fuel feed hole: M27x1.5
Fuel discharge hole: M20x1.5
Displacement: 20ml/r
Speed range: 5003200r/min
Max pressure: 13.5MPa
Rotation: L

Cross Ref.: 370H-3407100
Application: ZhuCheng Foton



Drawing No.: **3407 2127 001**

Controlled flow: 22L/min
Fuel feed hole: M27x1.5
Fuel discharge hole: M18x1.5
Displacement: 21ml/r
Speed range: 5003900r/min
Max pressure: 16MPa
Rotation: R

Cross Ref.: 13186340x0083
Application: ZhuCheng Foton
2P49P6126S(YH)



Drawing No.: **3407 2156 001**

Controlled flow: 17.5L/min
Fuel feed hole: M27x1.5
Fuel discharge hole: M18x1.5
Displacement: 20ml/r
Speed range: 5003200r/min
Max pressure: 13MPa
Rotation: L

Cross Ref.: J3315-3407100D
Application: ZhuCheng Foton



Drawing No.: **3407 2152 001**

Controlled flow: 19L/min
Fuel feed hole: M20x1.5
Fuel discharge hole: M18x1.5
Displacement: 21ml/r
Speed range: 5003200r/min
Max pressure: 13MPa
Rotation: R

Cross Ref.: A3520-3407100
G0340300001A0
Application: ZhuCheng Foton



Drawing No.: **3407 2217 001**

Controlled flow: 25L/min
Fuel feed hole: M27x1.5
Fuel discharge hole: M18x1.5
Displacement: 22.6ml/r
Speed range: 5003900r/min
Max pressure: 16MPa
Rotation: R

Cross Ref.: G0340030030A0
Application: ZhuCheng Foton



Drawing No.: **3407 2153 001**

Controlled flow: 20L/min
Fuel feed hole: M27x1.5
Fuel discharge hole: M16x1.5
Displacement: 21ml/r
Speed range: 5003200r/min
Max pressure: 13MPa
Rotation: L

Cross Ref.: 2530-3407100
Application: ZhuCheng Foton



Drawing No.: **3407 2223 001**

Controlled flow: 25L/min
Fuel feed hole: M27x1.5
Fuel discharge hole: M18x1.5
Displacement: 22ml/r
Speed range: 5003200r/min
Max pressure: 13MPa
Rotation: R

Cross Ref.: G0340030045A0
Application: ZhuCheng Foton

Pictures And/Or OEM Part Numbers are for reference purpose only.

 <p>Drawing No.: 3407 2802 001</p>	<p>Controlled flow: 27L/min Fuel feed hole: M27x1.5 Fuel discharge hole: M18x1.5 Displacement: 28ml/r Speed range: 5003200r/min Max pressure: 15MPa Rotation: R</p> <p>Cross Ref.: G0340030017A0 Application: ZhuCheng Foton</p>
--	---

 <p>Drawing No.: 3407 6657 001</p>	<p>Controlled flow: 15L/min Fuel feed hole: M27x1.5 Fuel discharge hole: M16x1.5 Displacement: 16ml/r Speed range: 5003200r/min Max pressure: 13MPa Rotation: L</p> <p>Cross Ref.: G0340030039A0 Application: ZhuCheng Foton</p>
--	---

 <p>SORL No.: YBZ1010/215-000 Drawing No.: 3407 6679 001</p>	<p>Controlled flow: 18L/min Fuel feed hole: M27x1.5 Fuel discharge hole: M16x1.5 Displacement: 16ml/r Speed range: 5003200r/min Max pressure: 13MPa Rotation: L</p> <p>Cross Ref.: G0340030041A0 Application: ZhuCheng Foton</p>
--	---



Displacement: 16ml/r
 Controlled flow: 19L/min
 Max.pressure: 14MPa
 Speed range: 500~3600r/min
 Rotation: R
 Fuel feed hole: M26×1.5
 Fuel discharge hole: M18×1.5
 DZ9100130004/612600130266/17 teeth

SORL No.: **3407 5001 001**

Application: SINOTRUCK Steyr/
SHACMAN/WD615



Displacement: 12ml/r
 Controlled flow: 28.73L/min
 Max.pressure: 21MPa
 Speed range: 500~3600r/min
 Rotation: R
 Fuel feed hole: Φ17.3
 (PCD39.7-2×5/16-18UNC)
 Fuel discharge hole: Φ14
 (PCD30.2-2×1/4-20UNC)
 Application: MAHINDRA
 AGRICULTURAL TARCTOR

SORL No.: **2513 12001 001**



Displacement: 20ml/r
 Controlled flow: 22L/min
 Max.pressure: 15MPa
 Speed range: 500~3600r/min
 Rotation: R
 Fuel feed hole: M26×1.5
 Fuel discharge hole: M18×1.5

SORL No.: **3407 5002 001**

Cross Ref: 612600130523/17 teeth
Application: SINOTRUCK Steyr DOUBEL
AXLE/WD615



Displacement: 12ml/r;8ml/r
 Controlled flow: 28.73L/min;
 19.15L/min
 Max.pressure: 21MPa;15MPa
 Speed range: 500~600r/min
 Rotation: R
 Fuel feed hole: Φ50
 Fuel discharge hole: Φ14
 (PCD30.2-2×1/4-20UNC);1/2 BSP×14
 Application: MAHINDRA
 AGRICULTURAL TARCTOR

SORL No.: **2513 12003 001**



Displacement: 20ml/r
 Controlled flow: 22L/min
 Max.pressure: 15MPa
 Speed range: 500~3600r/min
 Rotation: R
 Fuel feed hole: M26×1.5
 Fuel discharge hole: M18×1.5

SORL No.: **3407 5003 001**

Cross Ref: 612600130515/17 teeth
Application: WP10



Displacement: 22ml/r
 Controlled flow: 22L/min
 Max.pressure: 15MPa
 Speed range: 500~3600r/min
 Rotation: R
 Fuel feed hole: M27×1.5
 Fuel discharge hole: M18×1.5

SORL No.: **3407 5005 001**

Cross Ref: 1331334002002/17 teeth
Application: FOTON AUMAN/WP10



Displacement: 16ml/r
 Controlled flow: 18L/min
 Max.pressure: 15MPa
 Speed range: 500~3600r/min
 Rotation: R
 Fuel feed hole: M26×1.5
 Fuel discharge hole: M18×1.5

SORL No.: **3407 5004 001**

Cross Ref: 612600130511/19 teeth
Application: SINGLE AXLE/WD12



Displacement: 22ml/r
 Controlled flow: 22L/min
 Max.pressure: 15MPa
 Speed range: 500~3600r/min
 Rotation: R
 Fuel feed hole: M27×1.5
 Fuel discharge hole: M18×1.5

SORL No.: **3407 5006 001**

Cross Ref: 1131334001012/19 teeth
Application: FOTON AUMAN/WD12



Displacement: 20ml/r
 Controlled flow: 28.5L/min
 Max.pressure: 18MPa
 Speed range: 500~3600r/min
 Rotation: L
 Fuel feed hole: Φ19
 Fuel discharge hole: Φ14
 (PCD30.2-4×M6)

SORL No.: **2513 20001 001**

Cross Ref:
Application: MAHINDRA



Displacement: 16ml/r
 Controlled flow: 19L/min
 Max.pressure: 15MPa
 Speed range: 500~3600r/min
 Rotation: R
 Fuel feed hole: M26×1.5
 Fuel discharge hole: M18×1.5

SORL No.: **3407 5007 001**

Cross Ref: DZ9100130027/19 teeth
Application: SHACMAN DOUBEL AXLE

Pictures And/Or OEM Part Numbers are for reference purpose only.



Displacement: 16ml/r
 Controlled flow: 16L/min
 Max.pressure: 15MPa
 Speed range: 500~3600r/min
 Rotation: R
 Fuel feed hole: M26×1.5
 Fuel discharge hole: M18×1.5

Cross Ref: DZ9100130011/17 teeth
 Application: SHACMAN SINGLE AXLE

SORL No.: **3407 5008 001**



Displacement: 16ml/r
 Controlled flow: 16L/min
 Max.pressure: 15.5MPa
 Speed range: 500~3600r/min
 Rotation: R
 Fuel feed hole: M26×1.5
 Fuel discharge hole: M18×1.5

Cross Ref: 17 teeth
 Application: SINOTRUCK Steyr SINGLE AXLE/WD615

SORL No.: **3407 5014 001**



Displacement: 20ml/r
 Controlled flow: 22L/min
 Max.pressure: 14MPa
 Speed range: 500~3600r/min
 Rotation: L
 Fuel feed hole: M18×1.5
 Fuel discharge hole: M18×1.5

Cross Ref: 3407020-600-0390/22 teeth
 Application: FAW DOUBLE AXLE

SORL No.: **3407 5009 001**



Displacement: 18ml/r
 Controlled flow: 20L/min
 Max.pressure: 13MPa
 Speed range: 500~3600r/min
 Rotation: R
 Fuel feed hole: M26×1.5
 Fuel discharge hole: M18×1.5

Cross Ref: 612600130522/17 teeth
 Application: SINOTRUCK Steyr/YOUNG MAN BUS

SORL No.: **3407 5015 001**



Displacement: 22ml/r
 Controlled flow: 25L/min
 Max.pressure: 15MPa
 Speed range: 500~3600r/min
 Rotation: L
 Fuel feed hole: M30×2
 Fuel discharge hole: M18×1.5

Cross Ref: 3407020-62H-0C48B /22 teeth
 Application: FAW J6/FAWDE 300hp

SORL No.: **3407 5010 001**



Displacement: 20ml/r
 Controlled flow: 24L/min
 Max.pressure: 14MPa
 Speed range: 500~3600r/min
 Rotation: R
 Fuel feed hole: M27×1.5
 Fuel discharge hole: M18×1.5

Cross Ref: 3407020-D614/17 teeth
 Application: FAW/WP10

SORL No.: **3407 5016 001**



Displacement: 22ml/r
 Controlled flow: 22L/min
 Max.pressure: 15MPa
 Speed range: 500~3600r/min
 Rotation: R
 Fuel feed hole: M22×1.5
 Fuel discharge hole: M20×1.5

Cross Ref: 3406Z61-001/11 teeth
 Application: DONGFENG /CUMMINS 6CT

SORL No.: **3407 5011 001**



Displacement: 16ml/r
 Controlled flow: 16L/min
 Max.pressure: 14MPa
 Speed range: 500~3600r/min
 Rotation: R
 Fuel feed hole: M27×1.5
 Fuel discharge hole: M18×1.5

Cross Ref: 3407020-D604/17 teeth
 Application: FAW/WP10

SORL No.: **3407 5017 001**



Displacement: 16ml/r
 Controlled flow: 16L/min
 Max.pressure: 13MPa
 Speed range: 500~3600r/min
 Rotation: R
 Fuel feed hole: M26×1.5
 Fuel discharge hole: M18×1.5

Cross Ref: 61500130037/17 teeth
 Application: SINOTRUCK Steyr SINGLE AXLE/WD615

SORL No.: **3407 5013 001**



Displacement: 20ml/r
 Controlled flow: 24L/min
 Max.pressure: 14MPa
 Speed range: 500~3600r/min
 Rotation: R
 Fuel feed hole: M27×1.5
 Fuel discharge hole: M18×1.5

Cross Ref: 3407020-D614//17 teeth
 Application: FAW/WP10

SORL No.: **3407 5018 001**

Pictures And/Or OEM Part Numbers are for reference purpose only.



Displacement: 16ml/r
 Controlled flow: 16L/min
 Max.pressure: 14MPa
 Speed range: 500~3600r/min
 Rotation: R
 Fuel feed hole: M27×1.5
 Fuel discharge hole: M18×1.5

SORL No.: **3407 5019 001**
 Cross Ref: 3407020-D604/17 teeth
 Application: FAW/WP10



Displacement: 18ml/r
 Controlled flow: 16L/min
 Max.pressure: 14MPa
 Speed range: 500~3600r/min
 Rotation: L
 Fuel feed hole: M27×1.5
 Fuel discharge hole: M18×1.5

SORL No.: **3407 5030 001**
 Cross Ref: 23 teeth
 Application:



Displacement: 20ml/r
 Controlled flow: 20L/min
 Max.pressure: 14MPa
 Speed range: 500~3600r/min
 Rotation: R
 Fuel feed hole: M26×1.5
 Fuel discharge hole: M16×1.5

SORL No.: **3407 5020 001**
 Cross Ref: 13026661/16 teeth
 Application: WP6



Displacement: 22ml/r
 Controlled flow: 12L/min
 Max.pressure: 14MPa
 Speed range: 500~3600r/min
 Rotation: R
 Fuel feed hole: M27×1.5
 Fuel discharge hole: M18×1.5

SORL No.: **3407 5032 001**
 Cross Ref:
 Application:



Displacement: 16ml/r
 Controlled flow: 18L/min
 Max.pressure: 13MPa
 Speed range: 500~3600r/min
 Rotation: L
 Fuel feed hole: M18×1.5
 Fuel discharge hole: M16×1.5

SORL No.: **3407 5021 001**
 Cross Ref: 19 teeth
 Application: FAWDE/FAWDDE



Displacement: 25ml/r
 Controlled flow: 22L/min
 Max.pressure: 13MPa
 Speed range: 500~3600r/min
 Rotation: R
 Fuel feed hole: M27×1.5
 Fuel discharge hole: M18×1.5

SORL No.: **3407 5033 001**
 Cross Ref: 17 teeth
 Application:



Displacement: 20ml/r
 Controlled flow: 25L/min
 Max.pressure: 15MPa
 Speed range: 500~3600r/min
 Rotation: R
 Fuel feed hole: M26×1.5
 Fuel discharge hole: M18×1.5

SORL No.: **3407 5027 001**
 Cross Ref: 28 teeth
 Application: WP12



Displacement: 22ml/r
 Controlled flow: 20L/min
 Max.pressure: 15MPa
 Speed range: 500~3600r/min
 Rotation: R
 Fuel feed hole: Φ25
 Fuel discharge hole: M16×1.5

SORL No.: **3407 5034 001**
 Cross Ref:
 Application: HINO



Displacement: 16ml/r
 Controlled flow: 20L/min
 Max.pressure: 14MPa
 Speed range: 500~3600r/min
 Rotation: L
 Fuel feed hole: M18×1.5
 Fuel discharge hole: M16×1.5

SORL No.: **3407 5028 001**
 Cross Ref: 16 teeth
 Application: FAW 16T
 DOUBLE AXLE



Displacement: 25ml/r
 Controlled flow: 26L/min
 Max.pressure: 16MPa
 Speed range: 500~3600r/min
 Rotation: R
 Fuel feed hole: M33×2
 Fuel discharge hole: M20×1.5

SORL No.: **3407 5036 001**
 Cross Ref: K5200-3407100/11 teeth
 Application: YC6K12460-30

Pictures And/Or OEM Part Numbers are for reference purpose only.



Displacement: 16ml/r
 Controlled flow: 12L/min
 Max.pressure: 10MPa
 Speed range: 500~3600r/min
 Rotation: R
 Fuel feed hole: M27×1.5
 Fuel discharge hole: M18×1.5

SORL No.: **3407 5037 001**
 Cross Ref: 32 teeth
 Application:



Displacement: 18ml/r
 Controlled flow: 16L/min
 Max.pressure: 15MPa
 Speed range: 500~3600r/min
 Rotation: L
 Fuel feed hole: M27×1.5
 Fuel discharge hole: M18×1.5

SORL No.: **3407 5048 001**
 Cross Ref: 23 teeth
 Application: YC6108



Displacement: 18ml/r
 Controlled flow: 20L/min
 Max.pressure: 15MPa
 Speed range: 500~3600r/min
 Rotation: L
 Fuel feed hole: M30×2
 Fuel discharge hole: M18×1.5

SORL No.: **3407 5041 001**
 Cross Ref: 3407020A604-0655/22 teeth
 Application: FAW J6 SINGLE AXLE/
 FAWDE



Displacement: 18ml/r
 Controlled flow: 16L/min
 Max.pressure: 15MPa
 Speed range: 500~3600r/min
 Rotation: L
 Fuel feed hole: M27×1.5
 Fuel discharge hole: M16×1.5

SORL No.: **3407 5050 001**
 Cross Ref: 23 teeth
 Application: YC6108



Displacement: 18ml/r
 Controlled flow: 20L/min
 Max.pressure: 15MPa
 Speed range: 500~3600r/min
 Rotation: L
 Fuel feed hole: M27×1.5
 Fuel discharge hole: M16×1.5

SORL No.: **3407 5043 001**
 Cross Ref:
 Application: YC6108/YC6105



Displacement: 12ml/r
 Controlled flow: 10L/min
 Max.pressure: 13MPa
 Speed range: 500~3600r/min
 Rotation: L
 Fuel feed hole: Φ20
 Fuel discharge hole: M20×1.5

SORL No.: **3407 5059 001**
 Cross Ref: 11 teeth
 Application: GOLDEN DRAGON



Displacement: 18ml/r
 Controlled flow: 20L/min
 Max.pressure: 15MPa
 Speed range: 500~3600r/min
 Rotation: L
 Fuel feed hole: M27×1.5
 Fuel discharge hole: M20×1.5

SORL No.: **3407 5046 001**
 Cross Ref: 23 teeth
 Application: YC6108



Displacement: 18ml/r
 Controlled flow: 14L/min
 Max.pressure: 14MPa
 Speed range: 500~3600r/min
 Rotation: R
 Fuel feed hole: M27×1.5
 Fuel discharge hole: M18×1.5

SORL No.: **3407 5062 001**
 Cross Ref:
 Application: YN4102



Displacement: 18ml/r
 Controlled flow: 20L/min
 Max.pressure: 15MPa
 Speed range: 500~3600r/min
 Rotation: L
 Fuel feed hole: M27×1.5
 Fuel discharge hole: M18×1.5

SORL No.: **3407 5047 001**
 Cross Ref: 23 teeth
 Application: YC6108

Pictures And/Or OEM Part Numbers are for reference purpose only.

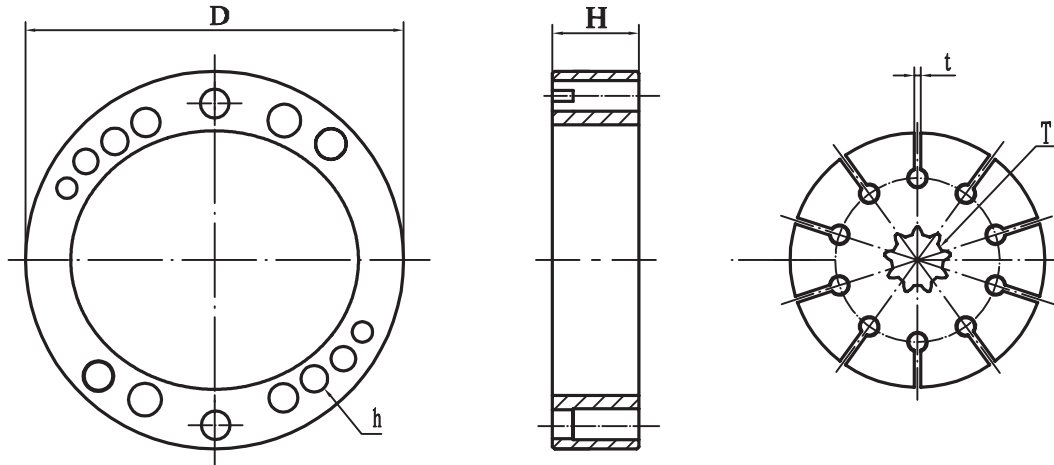

NO.	SORL PART NO.	CROSS REF.	APPLICATION	D(mm)	H(mm)	T	h	t	DIMENSION
1	3407 9918 900	475-10050	Fuso	64.6	12	10	10	2	64,6×12mm×10T×10h×2t
2	3407 9919 900	475-10052	lhww	64.6	14	10	10	2	64,6×14mm×10T×10h×2t
3	3407 9920 900	475-10056	Fuso 6D15	64.6	16	10	10	2	64,6×16mm×10T×10h×2t
4	3407 9921 900	475-10057	Fuso 6D14/6D15/CK12, Hyundai, Mitsubishi	64.6	18	10	10	2	64,6×18mm×10T×10h×2t
5	3407 9921 900	14714-99004	Fuso 6D14/6D15/CK12, Hyundai, Mitsubishi	65	18	10	10	2	65×18mm×10T×10h×2t
6	3407 9922 900	475-10058	Isuzu, Nissan, Hyundai, Fuso RD8/CK20/6D16, Mitsubishi	64.6	21	10	10	2	64,6×21mm×10T×10h×2t
7	3407 9923 900	475-10063	Isuzu, Nissan, Hyundai, Fuso Mitsubishi, Isuzu V10, 6BG1 6QA1, 8DC9	64.6	24	10	10	2	64,6×24mm×10T×10h×2t
8	3407 9924 900	475-10065	Isuzu, Nissan, Hyundai, Fuso Mitsubishi	64.6	30	10	10	2	64,6×30mm×10T×10h×2t
9	3407 9925 900	475-10069	Isuzu, Nissan, Hyundai, Fuso Mitsubishi	64.6	32	10	10	2	64,6×32mm×10T×10h×2t
10	3407 9926 900	475-10050B	Fuso	64.6	12	10	14	2	64,6×12mm×10T×14h×2t
11	3407 9927 900	475-10052B	lhww	64.6	14	10	14	2	64,6×14mm×10T×14h×2t
12	3407 9928 900	475-10056B	Fuso 6D15	64.6	16	10	14	2	64,6×16mm×10T×14h×2t
13	3407 9929 900	475-10057B		64.6	18	10	14	2	64,6×18mm×10T×14h×2t
14	3407 9930 900	475-10058B	Isuzu, Nissan, Hyundai, Fuso RD8/CK20/6D16, Mitsubishi	64.6	21	10	14	2	64,6×21mm×10T×14h×2t
15	3407 9931 900	475-10063B	Isuzu, Nissan, Hyundai, Fuso Mitsubishi, Isuzu N10, 6BG1, 6QA1, 8DC9	64.6	24	10	14	2	64,6×24mm×10T×14h×2t

Pictures And/Or OEM Part Numbers are for reference purpose only.

NO.	SORL PART NO.	CROSS REF.	APPLICATION	D(mm)	H(mm)	T	h	t	DIMENSION
16	3407 9932 900	475-10065B	Isuzu,Nissan,Hyundai,Fuso, Mitsubishi	64.6	30	10	14	2	64.6×30mm×10T×14h×2t
17	3407 9933 900	475-10069B	Isuzu,Nissan,Hyundai,Fuso, Mitsubishi	64.6	32	10	14	2	64.6×32mm×10T×14h×2t
18	3407 9934 900	475-10055		64.6	15.6	10	10	2	64.6×15.6mm×10T×10h×2t
19	3407 9935 900	431-11127		64	12	18	6	2	64×12mm×18T×6h×1.6t
20	3407 9936 900	44306-1160K		64	14	18	6	2	64×14mm×18T×6h×1.6t
21	3407 9937 900	44306-1030	Hino ED200	68	16	16	10	2	68×16mm×16T×10h×1.6t
22	3407 9939 930	44306-1060	Hino ED200	64.5	16	14	3	2	64.5×16mm×14T×3h×1.6t
23	3407 9942 900	44306-1160	Hino EH700/H07V	64	16	18	6	2	64×16mm×18T×6h×1.6t
24	3407 9943 900	44306-1180		68	16	18	3	2	68×16mm×18T×3h×1.6t
25	3407 9944 900	44306-1150A	Hino	64	18	18	12	2	64×18mm×18T×12h×1.6t
26	3407 9946 900	44306-1090	Hino ED100,ZM	68	20	10	10	2	68×20mm×10T×10h×1.6t
27	3407 9947 900	44306-1100	Hino EK100/EF500	68	20	18	12	2	68×20mm×18T×12h×1.6t
28	3407 9948 900	44306-1150	Hino EK100EF750	64	20	18	12	2	64×20mm×18T×12h×1.6t
29	3407 9949 900	44306-1170	Hino ZM,PK,EF500,750	64	20	18	8	2	64×20mm×18T×8h×1.6t
30	3407 9950 900	14714-99017	Nissan CW520,CW54,RE8	64	28	18	8	2	64×12mm×18T×6h×1.6t
31	3407 9951 900	14714-99018	Nissan CW520,CW54,RE8	64	28	10	8	2	64×28mm×10T×8h×1.6t
32	3407 9952 900	14714-99019	Nissan	64	30	18	8	2	64×30mm×18T×8h×1.6t
33	3407 9953 900	14714-99020	Nissan	64	32	18	8	2	64×32mm×18T×8h×1.6t
34	3407 9954 900	14714-99011	Nissan PD6	92	19	16	4	2	92×19mm×16T×4h×1.6t
35	3407 9955 900	14714-99012	Nissan PE6	92	16	10	14	2	92×16mm×10T×14h×1.6t
36	3407 9956 900	14714-99100	Nissan RF8 PF6	64	23	18	8	2	64×23mm×18T×8h×1.6t
37	3407 9957 900	14714-99100A	Nissan RF8 PF6	64	23	10	8	2	64×23mm×10T×8h×1.6t
38	3407 9967 900	475-75550	TD50,Spz	77	26	10	1	1	77×26mm×10T×1h×1.4t
39	3407 9968 900	475-75560		77	26	19	1	1	77×26mm×19T×1h×1.4t
40	3407 9969 900	475-10055B		64.6	15.6	10	14	2	64.6×15.6mm×10T×14h×2t
41	3407 9970 900	ZF001	Mercedes	64.5	19.5	14	1	2	64.5×19.5mm×14T×1h×2t
42	3407 9971 900	ZF002	Mercedes	64.5	19.5	14	1	1	64.5×19.5mm×14T×1h×1.4t
43	3407 9972 900	ZF003	MAN	64.5	23.5	14	3	1	64.5×23.5mm×14T×3h×1.4t
44	3407 9973 900	ZF004	MAN	64.5	23.5	14	3	1	64.5×23.5mm×14T×3h×1.4t
45	3407 9974 900	ZF005	Volvo	64.5	19.5	14	3	1	64.5×19.5mm×14T×3h×1.4t
46	3407 9975 900	ZF006	Volvo	64.5	19.5	14	1	1	64.5×19.5mm×14T×1h×1.4t
47	3407 9976 900	ZF007	Volvo	64.5	23.5	14	3	1	64.5×23.5mm×14T×3h×1.4t
48	3407 9976 900	VOLVO-485	Volvo-485	64.5	23.5	14	1	2	64.5×23.5mm×14T×1h×2t
49	3407 9977 900	ZF008	Volvo	64.5	23.5	14	2	1	64.5×23.5mm×14T×2h×1.4t
50	3407 9978 900	ZF009	Mercedes	64.5	23.5	14	1	1	64.5×23.5mm×14T×1h×1.4t
51	3407 9979 900	ZF010	Tata LCV	64.5	18	14	3	2	64.5×18mm×14T×3h×2t
52	3407 9980 900	V10-005	Vikiers	77	22	23	14	1	77×77×22mm×23T×14h×1.4t
53	3407 9981 900	V10-006	Vikiers	77	27	23	14	1	77×77×27mm×23T×14h×1.4t
54	3407 9994 900	14714-99019A	Nissan	64	30	10	8	2	64×30mm×10T×8h×2t
55	3407 9808 900	ZF011		65	22	24	2	1	65×22mm×24T×2h×1.4t
56	3407 9802 900			64.5	23.5	23	3	1	64.5×23.5mm×23T×3h×1.4t

Pictures And/Or OEM Part Numbers are for reference purpose only.

NO.	SORL PART NO.	CROSS REF.	APPLICATION	D(mm)	H(mm)	T	h	t	DIMENSION
57	3407 9820 900			64.5	23.5	23	3	1	64.5×23.5mm×23T×3h×1.4t
58	3407 9901 900	C34		65.3	16.44	14	4	1	65.3×16.44mm×14T×4h×1.256t
59	3407 9904 900	DG001		64.5	19.5	14	4	2	64.5×19.5mm×14T×4h×2t
60	3407 9906 900	5320-3407244		78	22	24	8	1	78×22mm×24T×8h×1.4t
61	3407 9910 900	7672.260.103		64.5	19.5	14	3	1	64.5×19.5mm×14T×3h×1.4t
62	3407 9911 900	7673.260.102		64.5	19.5	14	3	1	64.5×19.5mm×14T×3h×1.4t
63	3407 9912 900	7674.260.101		64.5	23.5	23	3	1	64.5×23.5mm×23T×3h×1.4t
64	3407 9913 900			77	22	23	14	1	77×77×22mm×23T×14h×1.4t
65	3407 9914 900			77	15.6	23	14	1	77×77×15.6mm×23T×14h×1.4t
66	3407 9915 900	7673.260.151		64.5	19.5	14	2	1	64.5×19.5mm×14T×2h×1.4t
67	3407 9938 900	44306-1030K	Hino ED200	68	16	18	10	2	68×16mm×18T×10h×1.6t
68	3407 9940 900	44306-1060A	Hino RH700,H07C	64.5	16	14	3	2	64.5×16mm×14T×3h×2t
69	3407 9941 900	44306-1060B	Hino RH700,H07V	64.5	16	14	3	2	64.5×16mm×14T×3h×2t
70	3407 9958 900	14714-99100B	Nissan RF8,PF8	64	23	18	10	2	68×16mm×18T×10h×1.6t
71	3407 9959 900	470-10059	Toyota 6HH1	54	16	14	6	2	54×16mm×14T×6h×1.6t
72	3407 9960 900	1-19519303-0	Toyota 6HH1	54	14	14	6	2	54×14mm×14T×6h×1.6t
73	3407 9983 900	LUK-001	Scania	63.5	23.5	23	10	1	63.5×23.5mm×23T×10h×1.4t
74	3407 9984 900	LUK-002	Scania	63.5	23.5	23	10	1	63.5×23.5mm×23T×10h×1.4t
75	3407 9985 900	14714-99020A	Nissan	64	32	10	8	2	64×32mm×18T×8h×1.6t
76	3407 9987 900		Tata HCV	64.5	19.5	14	3	2	64.5×19.5mm×14T×3h×2t
77	3407 9988 900	7672.260.103		64.5	19.56	14	3	1	64.5×19.56mm×14T×3h×1.4t
78	3407 9989 900	7673.260.102		64.5	19.56	14	3	1	64.5×19.56mm×14T×3h×1.4t
79	3407 9990 900	7674.260.101		64.5	23.5	14	3	1	64.5×23.5mm×14T×3h×1.4t
80	3407 9622 900	V20-006	Vikiers	113	15.6	30	16	2	113×113×15.6mm×30T×16h×1.7t
81	3407 9623 900			64	16	18	6	2	64×16mm×18T×6h×1.6t

Remark: The above part numbers include Cam Ring, Rotor and Vane only!



PART NO.	DIMENSION
475-10050	12mm×10T
475-10052	14mm×10T
475-10055	15.6mm×10T
475-10056	16mm×10T
475-10057	18mm×10T
475-10058	21mm×10T
475-10063	24mm×10T
475-10065	30mm×10T
475-10069	32mm×10T



PART NO.	DIMENSION
475-10050B	12mm×10T
475-10052B	14mm×10T
475-10055B	15.6mm×10T
475-10056B	16mm×10T
475-10057B	18mm×10T
475-10058B	21mm×10T
475-10063B	24mm×10T
475-10065B	30mm×10T
475-10069B	32mm×10T



PART NO.	DIMENSION
44306-1170	20mm×18T
14714-99100	23mm×18T
14714-99017	28mm×18T
14714-99019	30mm×18T
14714-99020	32mm×18T
431-11127	12mm×18T



PART NO.	DIMENSION
14714-99100A	23mm×10T
14714-99018	28mm×10T
14714-99019A	30mm×10T



PART NO.	DIMENSION
431-11127	12mm×18T
44306-1160K	14mm×18T
44306-1160	16mm×18T



PART NO.	DIMENSION
44306-1180	Φ68
44306-1060	Φ64



PART NO.	DIMENSION
44306-1150A	18mm×18T
44306-1150	20mm×18T



PART NO.	DIMENSION
44306-1090	20mm×10T



PART NO.	DIMENSION
44306-1030	16mm×10T



PART NO.	DIMENSION
475-75550	26mm×10T
475-75560	26mm×19T







PART NO.	DIMENSION
1-19519135-0	14mm×14T
470-10059	16mm×14T

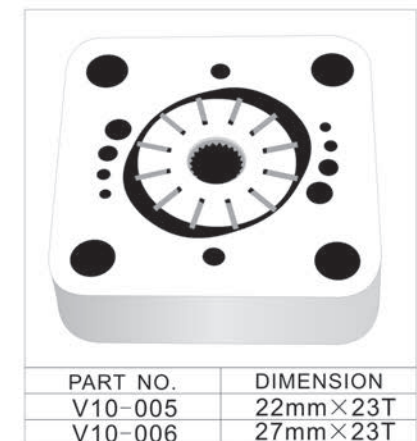
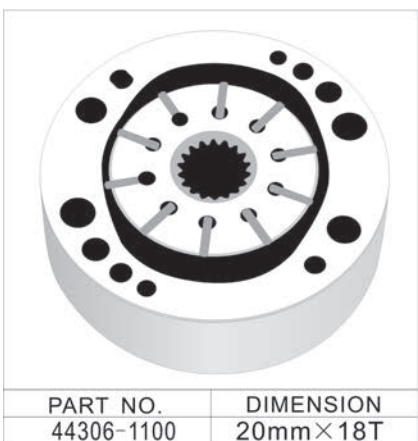
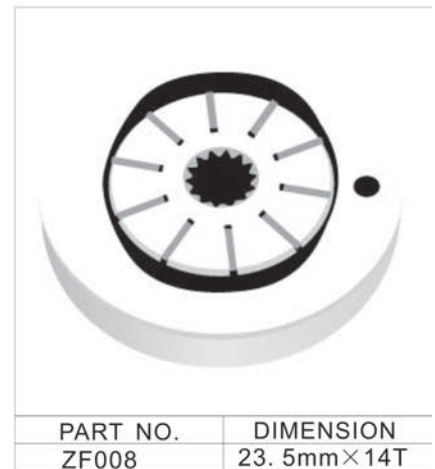
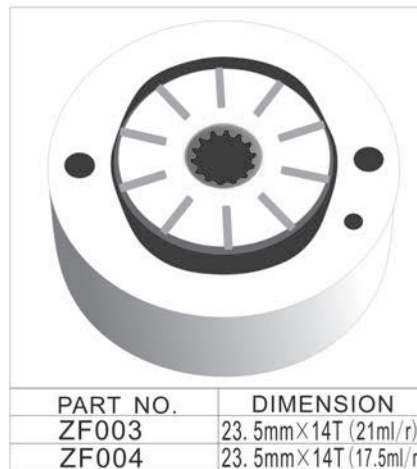
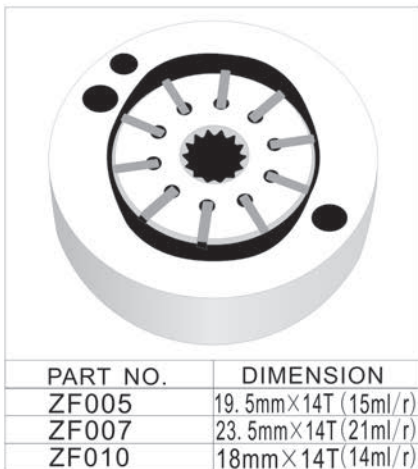
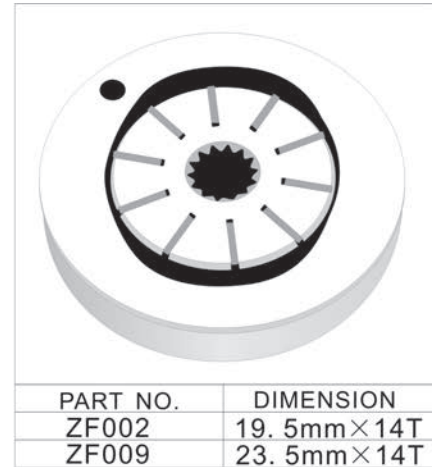
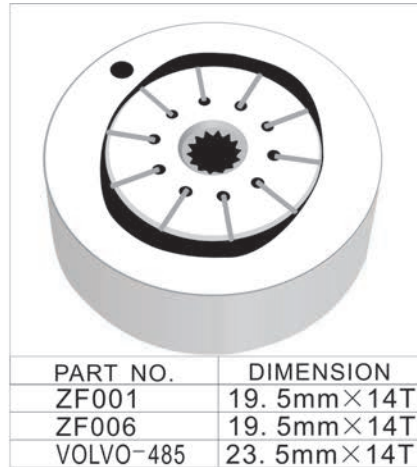
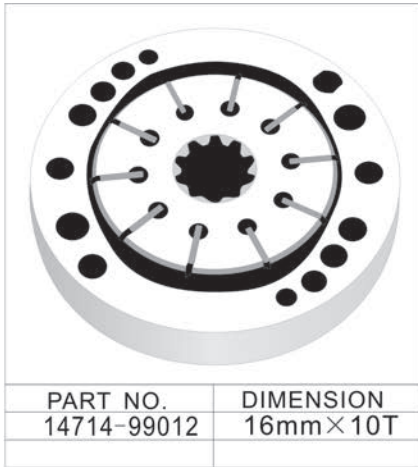

PART NO.	DIMENSION
14714-99011	19mm×14T



							
PART NO. 16D3-103	TPYE OF VEHICLE BENZ VOLVO	PART NO. 16D3-107	TPYE OF VEHICLE BENZ VOLVO	PART NO. 16F-103L	TPYE OF VEHICLE BENZ VOLVO	PART NO. 16F-107L	TPYE OF VEHICLE BENZ VOLVO
							
PART NO. 15B-103	TPYE OF VEHICLE FUSO 6D14/6D15	PART NO. 15B-103L	TPYE OF VEHICLE FUSO 6D14/6D15	PART NO. 20F-103	TPYE OF VEHICLE 8DC91	PART NO. 20F-107	TPYE OF VEHICLE 8DC91
							
PART NO. 20-103L	TPYE OF VEHICLE NISSAN	PART NO. 20-107L	TPYE OF VEHICLE NISSAN	PART NO. 20F1-103L	TPYE OF VEHICLE NISSAN	PART NO. 20F1-107L	TPYE OF VEHICLE NISSAN
							
PART NO. 20F1-103	TPYE OF VEHICLE NISSAN	PART NO. 20F1-107	TPYE OF VEHICLE NISSAN	PART NO. 16F1-103L	TPYE OF VEHICLE VOLVO	PART NO. 16F1-107L	TPYE OF VEHICLE VOLVO
							
PART NO. 15A-103	TPYE OF VEHICLE VOLVO	PART NO. 15A-107	TPYE OF VEHICLE VOLVO				

Pictures And/Or OEM Part Numbers are for reference purpose only.